

USER'S MANUAL



UNINTERRUPTIBLE POWER SUPPLY (UPS)

SPS.ADVANCE RT2

0,8.. 3 kVA

SALICRU

General index.

1. INTRODUCTION.

- 1.1. THANK YOU LETTER.

2. SAFETY INFORMATION.

- 2.1. USING THIS MANUAL.
 - 2.1.1. Conventions and symbols used.

3. QUALITY ASSURANCE AND STANDARDS.

- 3.1. STATEMENT BY THE MANAGEMENT.
- 3.2. STANDARDS.
- 3.3. ENVIRONMENT.

4. PRESENTATION.

- 4.1. VIEWS.
 - 4.1.1. Views of the device.
- 4.2. DEFINITION OF THE PRODUCT.
 - 4.2.1. Nomenclature.
- 4.3. OPERATING PRINCIPLE.
 - 4.3.1. Notable features.
- 4.4. OPTIONAL EXTRAS.
 - 4.4.1. Isolation transformer:
 - 4.4.2. Communication card.
 - 4.4.2.1. Integration into computer networks using an SNMP adapter.
 - 4.4.2.2. Modbus RS485.
 - 4.4.2.3. Interface to relays.
 - 4.4.3. Extendable guide kits for mounting in a rack cabinet.

5. INSTALLATION.

- 5.1. RECEPTION OF THE DEVICE.
 - 5.1.1. Reception, unpacking and contents.
 - 5.1.2. Storage.
 - 5.1.3. Unpacking.
 - 5.1.4. Transport to the site.
 - 5.1.5. Siting, immobilising and considerations.
 - 5.1.5.1. Rack-type mounting in a 19" cabinet.
 - 5.1.5.2. Rack-type mounting in a 19" cabinet with backup extension (battery module).
 - 5.1.5.3. Vertical tower-type mounting.
 - 5.1.5.4. Rotation of the control panel with LCD display.
 - 5.1.5.5. Vertical tower-type mounting with backup extension (battery module).
 - 5.1.5.6. Preliminary considerations before connection.

- 5.1.5.7. Preliminary considerations before connection, regarding the batteries and their protections.
- 5.2. CONNECTIONS.
 - 5.2.1. Connection of the input.
 - 5.2.2. Connection of the IEC output connectors.
 - 5.2.3. Connection to the optional battery module (backup extension).
 - 5.2.4. Terminals for EPO (emergency power off).
 - 5.2.5. Communication port.
 - 5.2.5.1. RS232 and USB port.
 - 5.2.6. Smart slot for the integration of an electronic communication unit.
 - 5.2.7. Protection against voltage spikes for the modem / ADSL / fax, etc., line.
 - 5.2.8. Software.
 - 5.2.9. Considerations before start-up with connected loads.

6. OPERATION.

- 6.1. START-UP.
 - 6.1.1. Checks before start-up.
- 6.2. UPS START-UP AND SHUTDOWN.
 - 6.2.1. UPS start-up with mains voltage.
 - 6.2.2. UPS start-up without mains voltage.
 - 6.2.3. UPS shutdown with mains voltage.
 - 6.2.4. UPS shutdown without mains voltage.

7. CONTROL PANEL WITH LCD DISPLAY.

- 7.1. GENERAL INFORMATION FOR THE SERIES.
 - 7.1.1. Information represented by the display.
 - 7.1.2. Other messages shown on the LCD display.
 - 7.1.3. Common abbreviations shown on the display.
- 7.2. COMPOSITION OF THE CONTROL PANEL WITH LCD DISPLAY.
- 7.3. AUDIBLE ALARMS.
 - 7.3.1. Location of the adjustment parameters on the display.
 - 7.3.2. Settings.
 - 7.3.2.1. Ah configuration of parameter '05'.
 - 7.3.2.2. Operating mode / Description of state.
 - 7.3.2.3. Warning or alert codes and indicators.
 - 7.3.2.4. Error or fault codes.

8. MAINTENANCE, WARRANTY AND SERVICE.

- 8.1. BATTERY MAINTENANCE.
 - 8.1.1. Notes for the installation and replacement of the battery.

8.2. UPS TROUBLESHOOTING GUIDE.

8.3. WARRANTY CONDITIONS.

8.3.1. Terms of the warranty.

8.3.2. Exclusions.

8.4. TECHNICAL SERVICES NETWORK.

9. ANNEXES.

9.1. GENERAL TECHNICAL SPECIFICATIONS.

9.2. GLOSSARY.

1. INTRODUCTION.

1.1. THANK YOU LETTER.

We thank you in advance for the trust placed in us in the purchasing of this product. Read this instruction manual carefully in order to familiarize yourself with its content, since the more you know and understand the equipment the greater your satisfaction, level of safety and optimization of its functionalities will be.

We remain at your disposal for any additional information or queries that you may wish to make.

Yours sincerely.

SALICRU

- The equipment described herein **is capable of causing significant physical damage in the event of improper handling**. For this reason its installation, maintenance and/or repair must be carried out exclusively by our personnel or by **qualified personnel**.
- Although no effort has been spared to ensure that the information in this user manual is complete and accurate, we are not responsible for any errors or omissions that may exist.
The images included in this document are for illustrative purposes and may not represent exactly the parts of the equipment shown, therefore they are not contractual. However, any divergence that may arise will be remedied or solved with the correct labelling on the unit.
- Following our policy of constant evolution, **we reserve the right to modify the characteristics, operations or actions described in this document without prior notice**.
- **Reproduction, copying, assignment to third parties, modification or total or partial translation** of this manual or document, in any form or by any means, **without previous written authorization by our firm is prohibited**, with the full and exclusive property rights over the same being reserved by our firm.

2. SAFETY INFORMATION.

2.1. USING THIS MANUAL.

The documentation of any standard equipment is available to the customer on our website for download (www.salicru.com).

- For devices "powered by socket", this is the website for obtaining the user manual and **"Safety Instructions"** EK266*08.
- For devices with "permanent connection" via terminals, a CD-ROM or pen drive containing all necessary information for connection and start-up, including **"Safety Instructions"** EK266*08, may be supplied with it.

Before carrying out any action on the device relating to its installation or start-up, change of location, configuration or handling of any kind, carefully read the safety instructions.

The purpose of the user manual is to provide information regarding safety and explanations of the procedures for installation and operation of the equipment. Read them carefully and follow the steps indicated in the order established.



Compliance with the "Safety Instructions" is mandatory and the user is legally responsible for compliance and enforcement.

The equipment is delivered properly labelled for the correct identification of each of the parts, which together with the instructions described in this user manual allows the operations of installation and commissioning to be performed in a simple and orderly manner without having any doubts whatsoever.

Finally, once the equipment is installed and operating, it is recommended to save the documentation downloaded from the website, CD-ROM or Pen Drive in a safe and easy-to-access place, for any future queries or doubts that may arise.

The following terms are used interchangeably in the document to refer to:

- **«SPS ADVANCE RT2, ADVANCE RT2, ADV RT2, RT2, equipment, unit or UPS»**.- Uninterruptible power supply system.
Depending on the context of the phrase, it can refer either to the actual UPS itself or to the the UPS and the batteries, regardless of whether it is all assembled in the same metal casing - box - or not.
- **"Batteries or accumulators"**.- Group or set of elements that stores the flow of electrons by electrochemical means.
- **'T.S.S.'** - Technical Service and Support.
- **'Client, installer, operator or user'** - These are used interchangeably and by extension to refer to the installer and/or operator who will carry out the corresponding actions, and the same person may be responsible for carrying out the respective actions when acting on behalf of, or in representation of, same.

2.1.1. Conventions and symbols used.

Some symbols may be used and appear on the equipment, batteries and/or in the context of the user manual.

For more information, see section 1.1.1 of document EK266*08 on **"Safety instructions"**.

3. QUALITY ASSURANCE AND STANDARDS.

3.1. STATEMENT BY THE MANAGEMENT.

Our goal is customer satisfaction, therefore this Management has decided to establish a Quality and Environment Policy, through the implementation of a Quality and Environmental Management System that will enable us to comply with the requirements demanded in the **ISO 9001** and **ISO 14001** and also by our Customers and Stakeholders.

Likewise, the management of the company is committed to the development and improvement of the Quality and Environmental Management System, through:

- Communication to the entire company of the importance of satisfying both the client's requirements as well as legal and regulatory requirements.
- The dissemination of the Quality and Environment Policy and the setting of the Quality and Environment objectives.
- Conducting reviews by the Management.
- Providing the necessary resources.

3.2. STANDARDS.

The SPS.ADVANCE RT2 is designed, manufactured and sold in accordance with Quality Management Standard **EN ISO 9001**. The **CE** marking indicates conformity with EC Directives through the application of the following standards:

- **2014/35/EU**. - Low voltage safety.
- **2014/30/EU**. - Electromagnetic Compatibility - EMC-.
- **2011/65/EU**. - Restriction of the use of hazardous substances in electrical and electronic equipment (RoHS).

According to the specifications of the harmonized standards. Reference standards:

- **EN-IEC 62040-1**. Uninterruptible Power Supplies -UPS-. Part 1-1: General and safety requirements for UPS used in user access areas.
- **EN-IEC 62040-2**. Uninterruptible Power Supplies -UPS-. Part 2: EMC requirements.



The manufacturer accepts no liability in the event of modification of or intervention on the device by the user.



WARNING!:

SPS.ADVANCE RT2 0.8..3 kVA. This is a category C2 UPS. In a residential environment, this product may cause radio interference, in which case the user must take additional measures.

It is not appropriate to use this equipment in basic life support applications (BLS), where a failure of the former can render vital equipment out of service or significantly affect its safety or effectiveness. It is also not recommended in medical applications, commercial transport, nuclear installations, or other applications or loads, where a failure of the product can lead to personal or material damages.



The EC declaration of conformity of the product is available to the customer upon express request to our headquarters.

3.3. ENVIRONMENT.

This product has been designed to respect the environment and manufactured according to **ISO 14001**.

Recycling of the equipment at the end of its useful life:

Our company undertakes to use the services of authorized and regulatory companies to treat the set of products recovered at the end of their useful life (contact your distributor).

Packaging:

For the recycling of the packaging there must be compliance with the legal requirements in force, according to the specific regulations of the country where the equipment is installed.

Batteries:

Batteries pose a serious danger to health and the environment. The disposal of them shall be carried out in accordance with the laws in force.

4. PRESENTATION.

4.1. VIEWS.

4.1.1. Views of the device.

Figures 1 to 3 show illustrations of the devices according to box size in relation to the power rating of the model. However, because the product is constantly evolving, discrepancies or slight contradictions may arise. If in any doubt, the labelling on the equipment itself will always prevail.

i The nameplate of the device shows all of the values relating to its main properties and characteristics. Act accordingly for its installation.

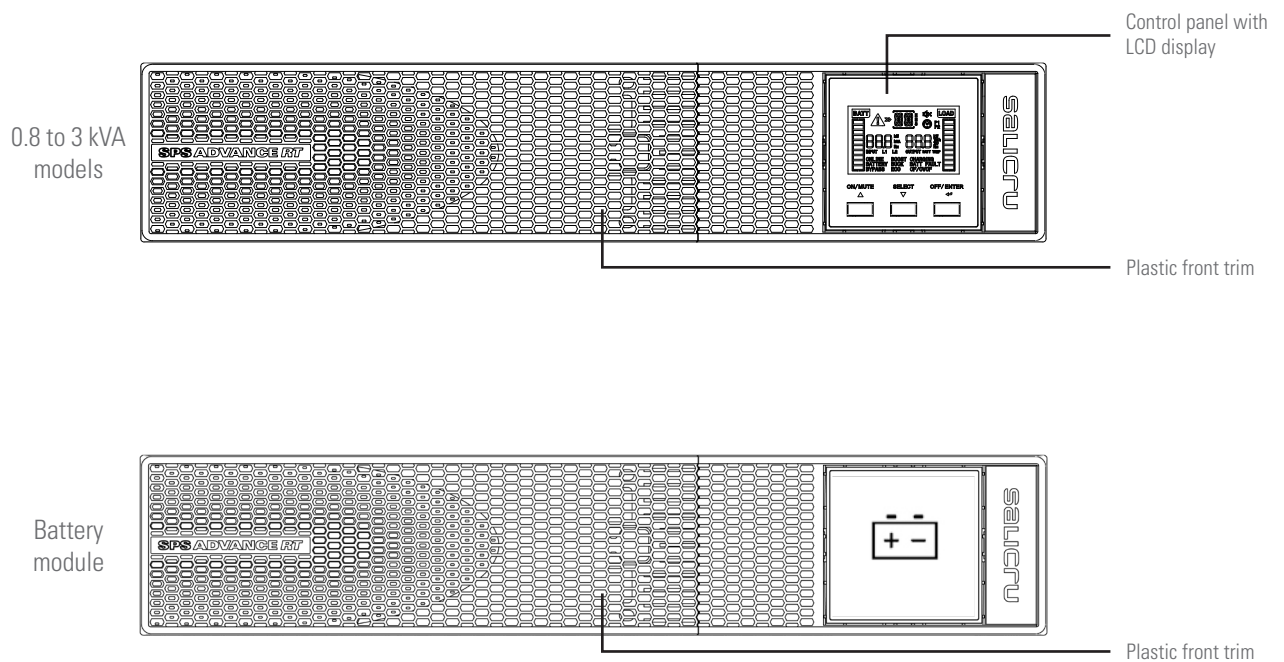

Fig. 1. Front view of the SPS.ADVANCE RT2 and battery module for extended backups.

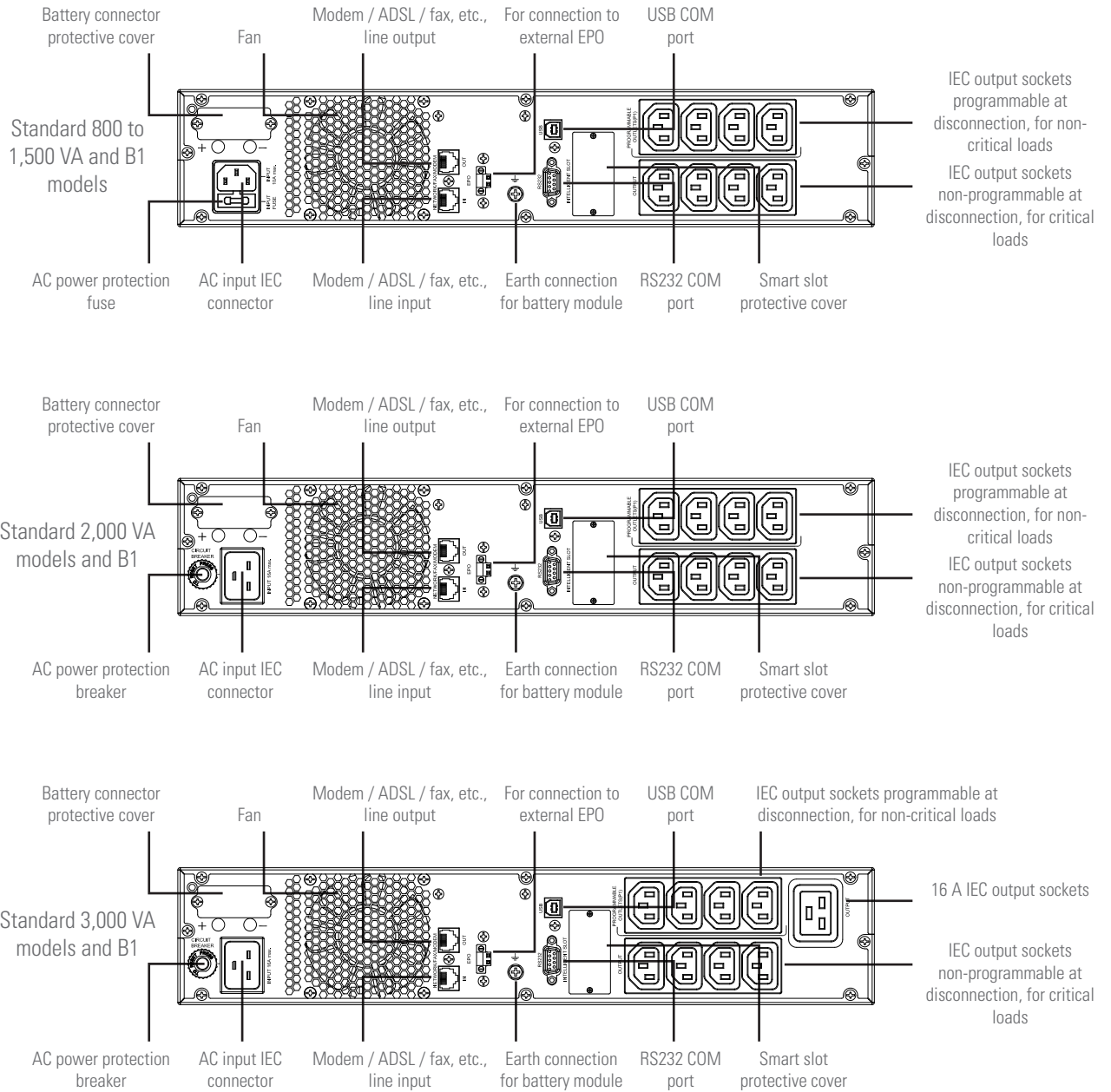
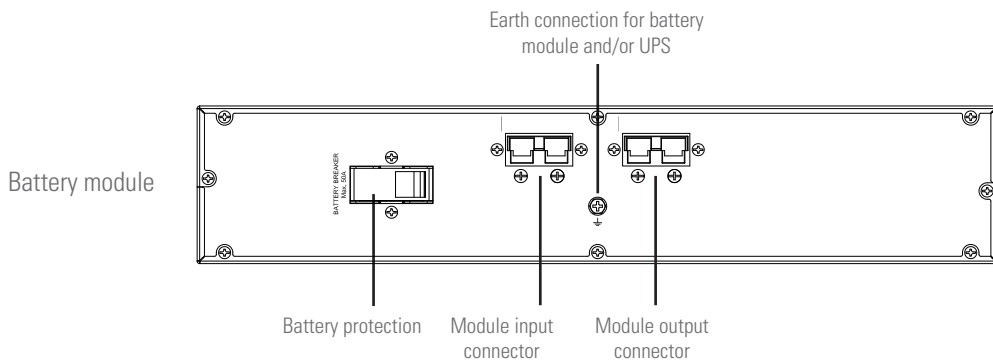

Fig. 2. Rear views according to device power ratings.



Connection of the battery module to the device and/or other module is made through the respective connectors.

Fig. 3. Rear view of battery modules for extended backups

4.2. DEFINITION OF THE PRODUCT.

4.2.1. Nomenclature.

SPS.1000.ADV RT2 B1 WCO 220/220 EE29503

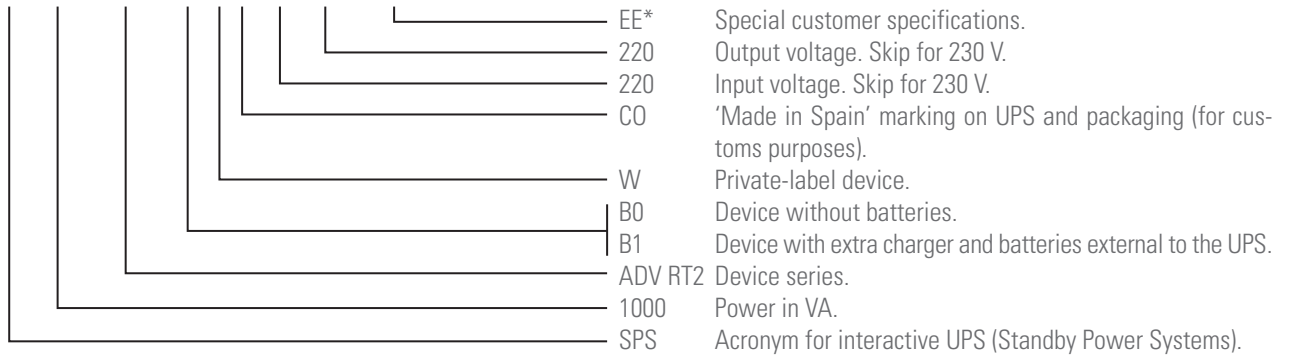

MOD BAT ADV RT2 2x6AB003 3x40A WCO EE29503

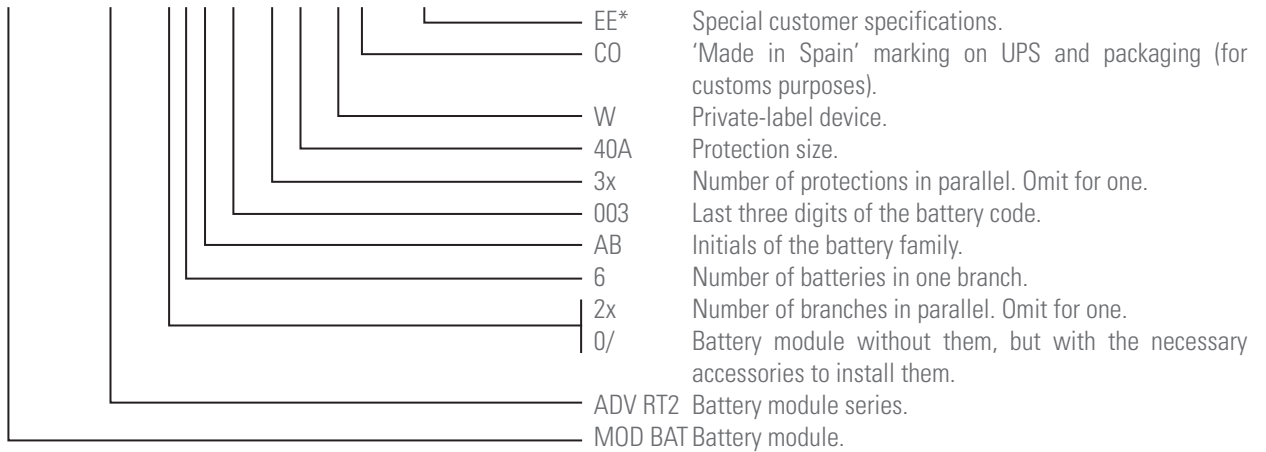

Note related to B0 and B1 batteries:

(B0) The device is supplied without batteries, but with a space reserved for installation in the same box for models whose standard version specifies this. For other models, the battery pack will be installed in the manner considered most appropriate (box, cabinet, rack, etc.).

For B0 devices ordered, the cost of acquisition, installation and connection of the batteries shall always be borne by the customer or distributor and **under their responsibility**.

Accessories such as screws, cables and battery connection plates are considered optional and can be supplied upon request.

(B1) Device with a more powerful charger, which does not have a battery pack, nor the possibility of installing them in the same box.

If an accumulator module is required, it will need to be ordered as a separate item, which will be connected to the UPS using the supplied cable.

Before connecting a module or group of batteries to the device or another available module, **it is necessary to check** that the voltage value printed on the back of the device next to the battery connector is appropriate and that the polarity between the means of connection corresponds. For more information, see Chapter 9 of this document.

4.3. OPERATING PRINCIPLE.

This user manual describes the installation and mode of operation of SPS.ADVANCE RT2 series UPSs for the power range between 800 and 3000 VA.

These line-interactive pure sine-wave output devices are designed to protect your most sensitive electronic devices against power supply problems including undervoltages, spikes, prolonged voltage drops, line noise and mains failures. SPS.ADVANCE RT2 devices are powered by the mains and supply AC power at their output through the IEC sockets installed on the back of the device. If mains supply is correct, the load or loads are powered from it through the stabiliser featuring buck-boost technology.

If mains supply is absent or the voltage and/or frequency are out of the acceptable range, the load or loads will be powered from the batteries through the inverter for a certain period of time depending on the model, battery charge level and load itself connected to the output.

In all of the models, it is possible to increase the standard backup of the devices by connecting additional modules and/or optimising the recharge time of the accumulators by incorporating higher performance chargers (B1).

The entire range of power ratings enables:

- The serial and USB ports for communication and control of the device. The serial port supports communications directly with a server and the protocol is in accordance with an RS232 interface, which also has dry-contact signals (interface to optocouplers).
- RJ-45 connectors for protecting the modem / ADSL / fax line.
- An EPO connector for optional, external installation by the user of an emergency stop button.
- A smart slot in which one of the following communication cards can be installed:
 - Integration into computer networks using an SNMP adapter.
 - Modbus RS485.
 - Interface to relays.

This manual applies to the standardised models shown in Tab. 1.

4.3.1. Notable features.

- Pure sine-wave output waveform, suitable for almost all types of load.
- Possibility of starting the device without mains power supply or discharged battery (cold start). Be careful with this aspect because the greater the batteries are discharged, the more the backup will be reduced.
- Great adaptability to the worst conditions of the mains. Wide input voltage, frequency and waveform ranges, thus avoiding excessive dependence on limited battery power.
- If mains supply is present and voltage and frequency are within the range, the built-in stabiliser featuring buck-boost technology powers the loads.
- Possibility of fast and easy backup extension by adding battery modules.
- Availability of additional battery chargers to reduce battery recharge time (B1).
- Intelligent battery management technology is very useful for extending the life of accumulators and optimising recharge times.

- Control panel with LCD display available on all models.
- Remote emergency power off control (EPO).
- Serial communication port: RS232 and USB.
- Availability of optional connectability cards to improve communication capabilities.
- Protection against overload, short circuit and overtemperature.
- Device that can be installed as a tower or rack using the accessories supplied. The control panel can be rotated to adapt to either format.

Model	Type	Input/output type
SPS.800.ADV RT2	Standard	Single-phase / Single-phase.
SPS.1100.ADV RT2		
SPS.1500.ADV RT2		
SPS.2000.ADV RT2		
SPS.3000.ADV RT2		
SPS.800.ADV RT2 (B0)	Without batteries	
SPS.1100.ADV RT2 (B0)		
SPS.1500.ADV RT2 (B0)		
SPS.2000.ADV RT2 (B0)		
SPS.3000.ADV RT2 (B0)		
SPS.800.ADV RT2 (B1)	Long backup with additional charger	
SPS.1100.ADV RT2 (B1)		
SPS.1500.ADV RT2 (B1)		
SPS.2000.ADV RT2 (B1)		
SPS.3000.ADV RT2 (B1)		

Tab. 1. Standardised models.

4.4. OPTIONAL EXTRAS.

Depending on the configuration chosen, the device may include any of the following options:

4.4.1. Isolation transformer:

The isolation transformer provides galvanic isolation in order to completely isolate the output from the input and/or change neutral mode.

The placement of an electrostatic screen between the primary and secondary windings of the transformer provides a high level of electrical noise attenuation.

The isolation transformer can be physically placed at the input or output of the UPS depending on the technical conditions of the whole system (device supply voltage and/or load voltage, characteristics or their type, etc.).

In any event, it will always be supplied as a peripheral component external to the device itself in a separate box.

4.4.2. Communication card.

The UPS features a slot at the rear for inserting one of the following communication cards.

4.4.2.1. Integration into computer networks using an SNMP adapter.

Large computer systems based on LANs and WANs that integrate servers in different operating systems must provide the system manager with ease of control and administration.

This facility is obtained through an SNMP adapter, which is universally supported by the main software and hardware manufacturers.

Connection of the UPS to the SNMP is internal while that of the SNMP to the computer network is made through a RJ45 10 base connector.

4.4.2.2. Modbus RS485.

Large computer systems based on LANs and WANs often require that communication with any element that is integrated into the computer network be made through a standard industrial protocol.

One of the most used standard industrial protocols on the market is the MODBUS protocol. The SPS.ADVANCE RT2 series can also be integrated into these types of environments using a Modbus RS485 card.

4.4.2.3. Interface to relays.

- The UPS has, as an option, an interface to relays card that provides digital signals in the form of potential-free contacts, with a maximum applicable voltage and current of 240 V AC or 30 V DC and 1A.
- This communication port enables dialogue between the device and other machines or devices through the relays supplied in the terminal block arranged on the same card, with a single common terminal for all of them.
From the factory, all contacts are normally open and can be changed one by one, as indicated in the information supplied with the optional extra.
- The most common use of these types of ports is to provide the necessary information to the file-closing software.
- For more information, contact our **T.S.S.** or our nearest distributor.

4.4.3. Extendable guide kits for mounting in a rack cabinet.

An extendable and unique guide kit is available for all device models, valid for any kind of rack-type cabinet.

These guides allow the installation of any device unit and possible battery modules in the case of extended backups, as if it were a rack in its respective cabinet.

5. INSTALLATION.

-  Read and respect the Safety Information described in Chapter 2 of this document. Failure to obey some of the instructions described in this manual can result in a serious or very serious accident to persons in direct contact or in the vicinity, as well as faults in the equipment and/or loads connected to it.

5.1. RECEPTION OF THE DEVICE.

- Pay attention to section 1.2.1. of the safety instructions -EK266 * 08- in all matters relating to the handling, movement and location of the unit.
- Use the most appropriate means to move the UPS.
- Any handling of the device must be carried out in accordance with the weights shown in the technical specifications according to the model, indicated in chapter '9. Annexes'.

5.1.1. Reception, unpacking and contents.

- Reception. Check that:
 - The data on the label affixed to the packaging correspond to those specified in the order. Once the UPS is unpacked, check the previous data with those of the equipment nameplate.
If there are discrepancies, file the disagreement as soon as possible, citing the equipment manufacture number and the delivery note references.
 - There is no damage to the packaging that may have occurred during transportation.
If there is damage, notify the carrier and indicate so on the delivery note, and, as soon as possible, inform the supplier / distributor or, failing that, our firm.
- Unpacking.
 - Remove the packaging to check the contents.
 -  Complete the unpacking according to the procedure in section 5.1.3.
- Content.
 - Device:
 - 1 UPS.
 - Quick guide on paper.
 - Information for warranty registration.
 - 1 USB cable.
 - 3 cables with IEC connectors for loads.
 - 1 cable for the device's AC power supply.
 - 2 metal pieces for use as handles and screws for installing the unit in a rack cabinet.
 - 4 plastic pieces for use as a base to facilitate the arrangement of the UPS as a tower (vertical position).
 - Optional battery module:
 - 1 battery module:
 - Information for warranty registration.
 - 2 metal pieces for use as handles and screws for installing the unit in a rack cabinet.
 - 2 plastic pieces to extend the base of the UPS and enable the arrangement of the attached battery module in its mounting as a tower.
 - 1 cable for interconnecting the battery module and UPS or other module.

- Once the reception is completed, it is advisable to re-pack the UPS until it is put into service in order to protect it against mechanical shock, dust, dirt, etc.
- The packaging of the device consists of a cardboard or wooden box, depending on the item, expanded polystyrene corners, polyethylene cover and strapping, all of which are recyclable materials. When the packaging requires disposal, it must be carried out in accordance with current laws. We recommend keeping it for at least 1 year.

5.1.2. Storage.

- The device should be stored in a dry, ventilated room and protected from rain, dust, and water or chemical splashes. It is advisable to keep each device and battery unit in its original packaging, as it has been specifically designed to ensure maximum protection during transportation and storage.
-  For devices that contain Pb-Ca batteries, the charging times indicated in Tab. 2 of document EK266*08, determined by the temperature to which they are exposed, must be respected, otherwise the warranty may be invalidated.
- After this period, connect the device to the mains together with the battery unit if applicable according to the instructions described in this manual and charge for 12 hours.
- Then disconnect and store the UPS and batteries in their original packaging, noting the new date for recharging the batteries on a document as a record or even on the packaging itself.
- Do not store the devices where the ambient temperature exceeds 50°C or drops below -20°C, as this may cause degradation of the electrical characteristics of the batteries.

5.1.3. Unpacking.

- The packaging of the device consists of a cardboard box, expanded polystyrene (EPS) or polyethylene foam (EPE) corners, polyethylene cover and strapping, all of which are recyclable materials; consequently, if it requires disposal, it must be carried out in accordance with current laws. We recommend keeping the packaging in case it needs to be used in the future.
- Proceed as follows:
 - Cut the straps around the cardboard box.
 - Remove the accessories (cables, brackets, etc.)
 - Remove the device or battery module from the box with the help, if necessary, of a second person depending on the weight of the model or using appropriate mechanical means.
 - Remove the protective corners from the device and the plastic bag.
 -  Do not leave the plastic bag within the reach of children to avoid danger of suffocation.
 - Inspect the device before proceeding and, in the event of finding damage, contact the supplier / distributor or, failing that, our firm.

5.1.4. Transport to the site.

- It is advisable to move the UPS using the most suitable means for this. If the distance is considerable, it is recommended to transport the device in its packaging to the installation site and then unpack it.

5.1.5. Siting, immobilising and considerations.

- All SPS.ADVANCE RT2 devices are designed for rack mounting (horizontal installation in 19" cabinets) or tower mounting (vertical installation) as with their optional battery modules.
Follow the instructions indicated in relation to either of the two possibilities, according to the particular configuration of your device.
- Fig. 4..Fig. 8 show, by way of example, illustrations of a device with or without battery module. These illustrations provide help and guidance on the steps to follow, but the instructions are not intended to refer to a single model, although, in practice, the actions to be carried out are always the same for all of them.
- For all instructions regarding connections, refer to section 5.2.

5.1.5.1. Rack-type mounting in a 19" cabinet.

- Proceed as follows (see Fig. 4):
 - Using the supplied screws, fix the two adapter angles for use as handles on each side of the UPS, respecting its mounting orientation.
 - To install the device in a rack cabinet, it is necessary to have internal lateral guides for use as supports. Alternatively, and upon request, we can supply universal slides for use as guides, for installation by the user.

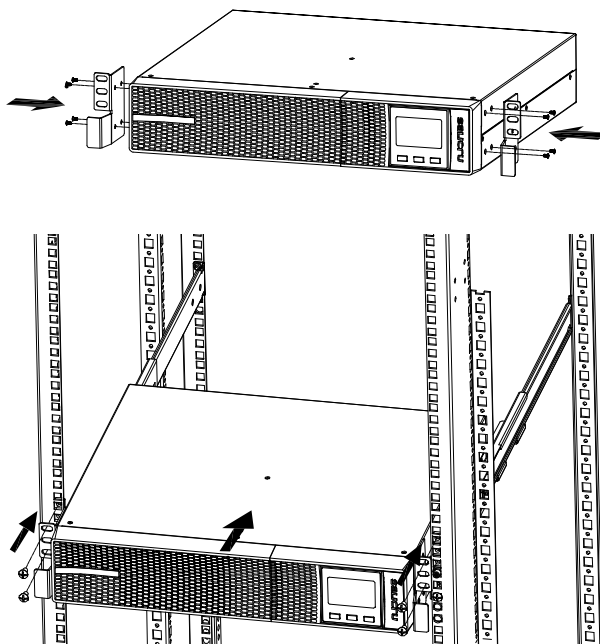

Fig. 4. Rack-type mounting in a 19" cabinet.

- Mount the guides at the required height, ensuring correct tightening of the fixing screws and appropriate fitting in the machining, according to each case.
- Place the device onto the guides and insert it all the way to the back.
Depending on the device model and weight, and/or whether it is installed in the upper or lower part of the cabinet, it is recommended that two people carry out the installation operations.
- Fix the UPS to the cabinet frame using the screws supplied with the handles.

5.1.5.2. Rack-type mounting in a 19" cabinet with backup extension (battery module).

- This section describes a device with one battery module. For more battery modules, repeat the same procedure for each of them.
- Proceed as follows (see Fig. 5):
 - Using the supplied screws, fix the two adapter angles for use as handles on each side of the UPS, respecting its mounting orientation. Repeat the same procedure for the battery module.

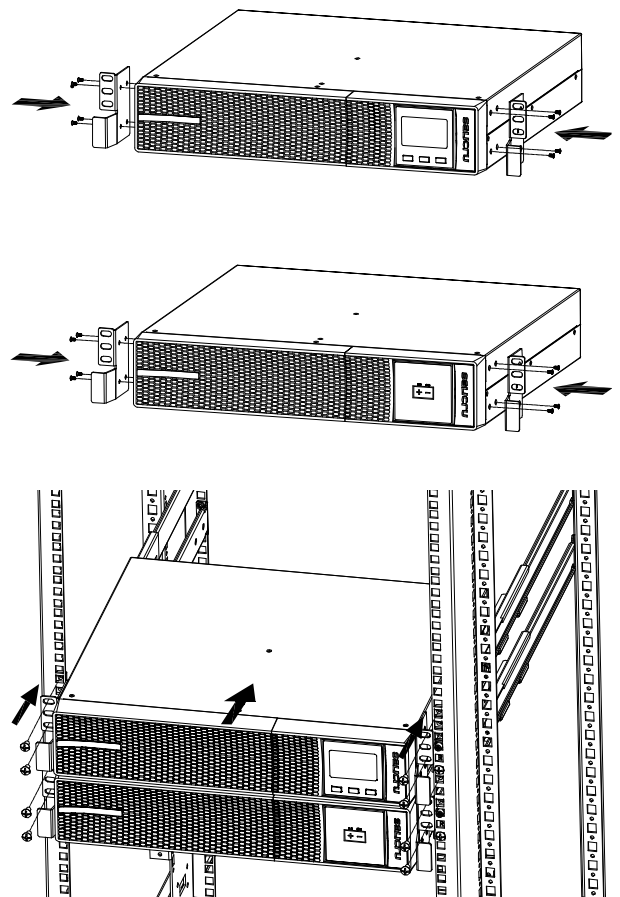

Fig. 5. Rack-type mounting in a 19" cabinet with backup extension (battery module).

- To install each unit, UPS and battery module in a rack cabinet, it is necessary to have internal lateral guides for use as supports. Alternatively, and upon request,

we can supply universal slides for use as guides, for installation by the user.

Mount the guides at the required height, ensuring correct tightening of the fixing screws and appropriate fitting in the machining, according to each case.

- ❑ Place the device onto the guides and insert it all the way to the back. Proceed in the same way for the battery module.

Depending on the weight of each unit according to the type of device and battery module, and/or whether it is installed in the upper or lower part of the cabinet, it is recommended that two people carry out the installation operations.

- ❑ Fix the UPS and the battery module to the cabinet frame by means of the screws supplied with the respective handles.

5.1.5.3. Vertical tower-type mounting.

- Take the 4 pieces of plastic supplied with the device and join them together in twos to obtain two bases.
- Place the UPS upright between the two bases at a distance of 70 mm from each end (see Fig. 6).

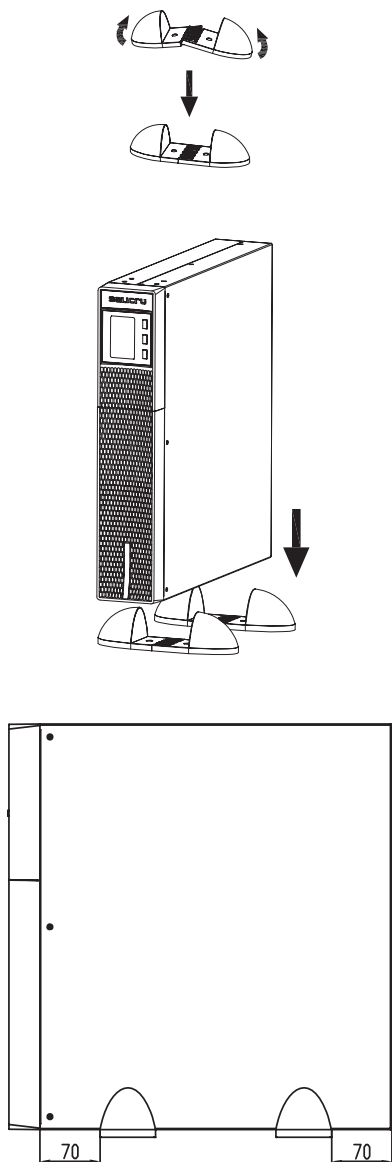

Fig. 6. Vertical tower-type mounting.

5.1.5.4. Rotation of the control panel with LCD display.

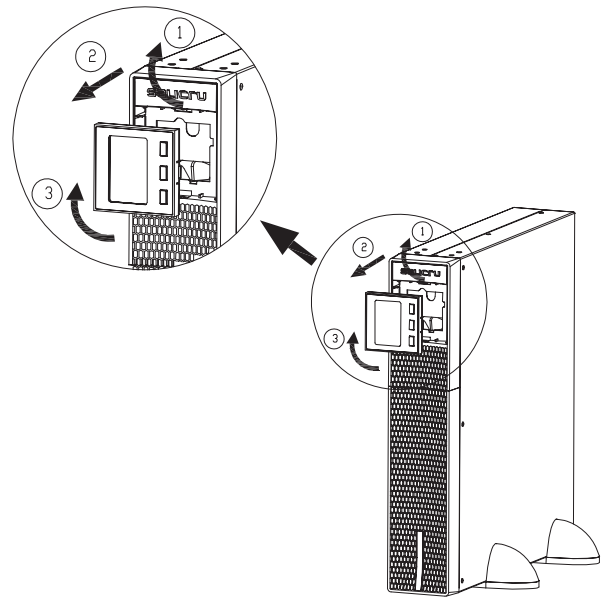

Fig. 7. Rotation of the control panel with LCD display on the plastic front trim.

- The device is initially set up at the factory for installation as a rack. To facilitate the reading of messages on the display when the device is installed vertically, it is advisable to rotate the control panel clockwise by 90° (see Fig. 7).
- Proceed as follows:
 - ❑ Insert fingertips into the recesses of the plastic trim around the display and pull outwards.
 - ❑ Rotate the control panel with LCD display 90° to the right with respect to its initial position and insert it back into the front.
- Likewise, it is recommended to reverse the rotation of the control panel if a device arranged as a tower needs to be installed as a rack. In this case, the rotation of the control panel will be anti-clockwise.

5.1.5.5. Vertically mounted tower-type model with backup extension (battery module).

- The description in this section refers to a device with a single battery module. For a greater number, proceed in a similar way.
- Take the 4 plastic pieces in the form of an angle supplied with the UPS and the two extensions supplied with the battery module, and install them to obtain two bases to hold the device and the battery module.
- Place the UPS and battery module upright between the two bases (see Fig. 8) and at a distance of 70 mm from each end, as shown in Fig. 6.
- Rotate the control panel according to section 5.1.5.4.

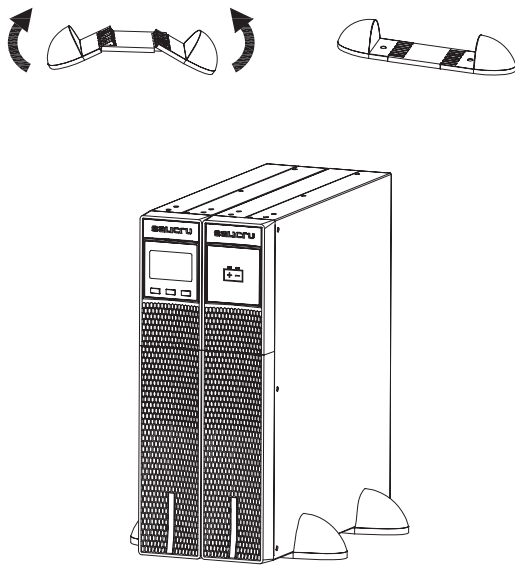





Fig. 8. Vertically mounted tower-type model with backup extension (battery module).

5.1.5.6. Preliminary considerations before connection.



- Check that the information on the device's nameplate is that required for installation.
- All devices in the range feature a cord with plug for the input and IEC connectors for the output, as connecting elements for power. Other connections are made through connectors, including connection of the device to the battery module.
- Thermal control of these devices is carried out with the passage of forced air from the front to the rear. The front surface and about 15 cm on the rear side should be left free of obstructions to facilitate the free circulation of air for ventilation.
- Protection board:
It will have a type-B differential circuit breaker and a short circuit protection (C-curve circuit breaker) for the UPS's input line.
As for size, they will be at least the current indicated on the nameplate of the UPS.
- Only the rated current as indicated by the EN-IEC 62040-1 safety standard is printed on the nameplate of the device. For the calculation of the input current, the power factor and the equipment's own performance have been considered.

Overload conditions are considered a non-permanent and exceptional working mode.



- The cross section of the input line cables is determined by the current indicated on the nameplate of each device, in compliance with local and/or national Low-Voltage Electrotechnical Regulations.
- If peripheral input and/or output elements, such as transformers or autotransformers, are added to the UPS, the currents indicated on the nameplates of these elements must be taken into consideration when determining appropriate cross sections, in compliance with local and/or national Low Voltage Electrotechnical Regulations.
-  When a device incorporates a galvanic isolation transformer as an optional extra or installed independently, either at the input, output or both, it must be fitted with protection against indirect contact (differential circuit breaker) at the output of each transformer, since, due to its own insulation properties, it will prevent the tripping of the protections placed on the primary of the isolation transformer in case of electric shock on the secondary (output of the isolation transformer).
- We remind you that all the isolation transformers installed or factory supplied, have the output neutral grounded through a bridge between the neutral terminal and ground. If the isolated output neutral is required, this bridge must be removed, taking the precautions indicated in the respective local and/or national low voltage regulations.
-  This device is suitable for installation in networks with TT, TN-S, TN-C or IT power distribution systems, taking into account at the time of installation the particularities of the system used and the national electrical regulations of the destination country.
-  All of the models in this series have an input polarity detector (phase-neutral), which activates a modulated audible alarm every 2 seconds and displays the message on the 'SF' display in the event of a fault.
When the circumstance arises, disconnect the plug from the mains socket and rotate it 180°.
If the same alarm condition is maintained, it will be a two-phase power line signal or installation without neutral referenced to earth. Contact our **T.S.S.** or the distributor before connecting loads to the output.
- The ADVANCE RT2 features terminals for the installation of an external emergency power off button (EPO) or, failing that, a single device must be installed to cut the power supply to the loads in any operating mode.

5.1.5.7. Preliminary considerations before connection, regarding the batteries and their protections.



- SPS.ADVANCE RT2 devices incorporate the batteries in the same box as the device, except for B0 and B1 models. The UPS's battery protection is internal by means of fuses and is therefore not accessible to the user. The battery modules have a circuit breaker accessible to the user and a second internal protection consisting of a non-accessible fuse.
-  **IMPORTANT FOR SAFETY:** If batteries are installed independently, the accumulator group must be fitted with a bipolar circuit breaker or disconnect fuse of the size indicated in Tab. 2.

- Inside the battery module, there are HAZARDOUS VOLTAGES with risk of electric shock, so it is classified as a RESTRICTED ACCESS AREA.
-  Do not handle the battery circuit breaker when the device is running.
-  If the mains power of the device is cut for longer than a simple intervention and it is expected that it will be out of service for a prolonged period time, the system must be shut down completely.
-  The battery circuit is not isolated from the input voltage. Dangerous voltages can occur between the terminals of the battery group and the earth. Check that there is no input voltage before working on the battery module connectors.

5.2. CONNECTIONS.

- A bad connection or operation can cause faults in the UPS and/or the loads connected to it. Read the instructions in this manual carefully and follow the steps indicated in the order established.
-  The devices can be installed and used by personnel without specific training by simply using this manual.
-  It should never be forgotten that a UPS is a generator of electrical energy, and as such, the user must take all necessary precautions against direct or indirect contact.
-  All of the device's connections, including those related to control (interface, EPO, etc.), must be made without mains power present and the UPS set to 'Off'.
- To connect a device to an optional battery module, or between modules, or to install an optional card in the slot, it is necessary to remove its respective metal protective cover screwed to the UPS. Remove the screws and cover.

5.2.1. Connection of the input.

-  As the device has Class I protection against electric shock, it is obligatory and essential for the AC input socket to have the earth conductor () installed. Check that this is the case before continuing.
- Take the device's power cable, plug the female IEC connector into the UPS and the Schuko plug at the other end of the cable into an AC power socket.

5.2.2. Connection of the IEC output connectors.



- All UPSs have 'n' variable IEC output connectors according to the power rating of the device:
 - 0.8 to 2 kVA models.
2 groups of 4 x 10A IEC connectors identified as OUTPUT and PROGRAMMABLE OUTLETS (P1), the second group of which is programmable at disconnection for non-critical loads through the control panel or ViewPower software.
 - 3 kVA model.
The other models incorporate a 16 A IEC output connector in the OUTPUT connector group.
 -  Loads can be connected to all of the IEC connectors provided that the rated power of the device is not exceeded and the limitation of the programmable IEC socket group is considered,

otherwise untimely cuts will occur in the powering of the loads connected to them.

- If, in addition to the more sensitive loads, it is necessary to connect high-consumption inductive loads, such as for laser printers or CRT monitors, the starting up of these peripherals will need to be taken into account to prevent the device from crashing.



We do not recommend connecting loads of this type due to the amount of power they absorb from the UPS.

5.2.3. Connection to the optional battery module (backup extension).

-  **Failure to comply with the instructions in this section and Safety Instructions EK266*08 carries a high risk of electric shock and even death.**
- SPS.ADVANCE RT2 devices incorporate the batteries in the same box as the device, except for B0 and B1 models.
-  **IMPORTANT FOR SAFETY:** If batteries are installed independently, the accumulator group must be fitted with a bipolar circuit breaker or disconnect fuse of the size indicated in Tab. 2.

Model	Rated voltage of batteries	Minimum values, fast type fuses	
		DC voltage (V)	Current (A)
SLC-800-ADV RT2	(12 V x 2) = 24 V	125	32
SLC-1100-ADV RT2			50
SLC-1500-ADV RT2	(12 V x 4) = 48 V		32
SLC-2000-ADV RT2			40
SLC-3000-ADV RT2			40
	(12 V x 6) = 72 V		

Tab. 2. Protection features between device and battery module.

-  Before starting the connection process between the battery module or modules and the device, check that the UPS and the loads are set to 'Off' and that the battery voltage of all of them is the same, without exceptions. Also, when the batteries are installed by the user independently, the protection fuse or isolator must be deactivated.
- Connection of the battery module to the UPS is made by means of a cable featuring polarised connectors at both ends and supplied with the first one. Plug the connector at one end of the cable into the corresponding socket on the SPS.ADVANCE and the one on the other end into the battery module (see Fig. 9). In the same way, battery modules can be linked in parallel since each of them has two connectors. All of the connectors must be secured to their units by means of the screws that held the protective cover of each connector to the UPS or battery module.
-  As the device has Class I protection against electric shock, it is obligatory and essential to connect the earth conductor (). Connect the earth cable to the corresponding points identified, either terminal or screw (see Fig. 9). If the interconnection cable has a mesh, the earth connection will be linked between units through it by fixing the metal supports of the connectors to the UPS and battery module

or modules using the screws indicated in the previous point.

-  Each battery module is independent for each device.
- **Two devices must not be connected to the same battery module.**
- Fig. 9 shows the connection of a 3 kVA device in a rack arrangement with two battery modules. For a larger number, proceed in a manner similar to those shown in the illustration.

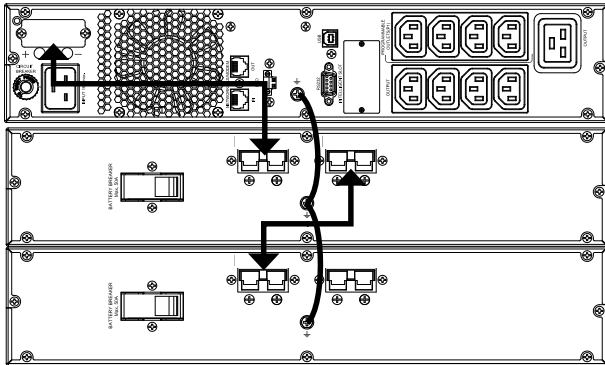

Fig. 9. Connection to battery modules.

5.2.4. Terminals for EPO (emergency power off).

- The UPSs have two terminals for the installation of an external emergency power off (EPO) output button.
- The device is dispatched from the factory with its EPO circuit set to closed (NC) by default. In other words, the UPS will cut the output power supply, emergency power off, when the circuit is opened:
 - Either by removing the female connector from the socket where it is inserted. This connector has a cable connected as a jumper that closes the circuit (see Fig. 10-A).
 - Or by pressing the button external to the device belonging to the user installed between the terminals of the connector (see Fig. 10-B). The connection on the button must be in the normally closed contact (NC), so it will open the circuit when activated.

The reverse functionality can be selected through the communications software and control panel.

Except for specific cases, we advise against this type of connection in view of the purpose of the EPO button, since it will not act upon an emergency request if either of the two cables that run from the button to the UPS is accidentally cut.

By contrast, this anomaly would immediately be detected in a closed EPO circuit, with the inconvenience of an unexpected cut in the powering of the loads, but a guarantee of effective emergency functionality.

- To recover the normal operating state of the UPS, it is necessary to insert the connector with the jumper in its receptacle or deactivate the EPO button. The device will be operational.

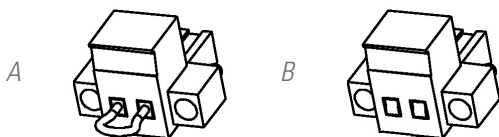



Fig. 10. Connector for external EPO.

5.2.5. Communication port.

5.2.5.1. RS232 and USB port.

-  The communications line -COM- constitutes a very low voltage safety circuit. To preserve the quality must be installed separately from other lines carrying dangerous voltages (power distribution line).
- The RS232 and USB interfaces are useful for the monitoring software and updating the firmware.
- It is not possible to use both the RS232 and USB ports at the same time.
- The DB9 connector supplies the RS232 signals and the normally open (NO) potential-free contacts using optocouplers. The maximum voltage and current applicable to these contacts is 30V DC and 1A.
- Also, there is a «Shutdown» input that allows turning off the inverter, when a voltage between 10 a 12 V is applied for 1 second at this input.
- The RS232 port consists of the transmission of serial data in such a way that a large amount of information can be sent through a communication cable with only 3 wires.
- The USB port is compatible with the USB 1.1 protocol for communication software.

Pin #	Description	Input / Output
1	End of backup	Output
2	TXD for RS232	Output
3	RXD for RS232	Input
4	GND for shutdown	Earth
5	GND for RS232	Earth
6	Common relays	-
7	Shutdown order	Input
8	Low battery	Output
9	Mains fault	Output

Tab. 3. Pinout of DB9 connector, RS232.

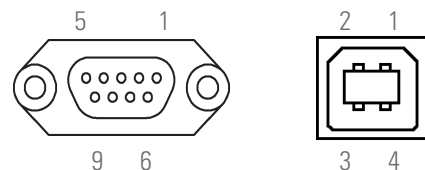

Fig. 11. DB9 connectors for RS232 and USB.

5.2.6. Smart slot for the integration of an electronic communication unit.

- Optional electronic communication units include:
 - Interface to relays to terminals, not programmable.
 - SNMP adapter.
 - Modbus RS485 adapter.
- The corresponding documentation is supplied with each option. Read it before starting installation.

Installation.

- Remove the protective cover from the device's slot.
- Take the corresponding electronic unit and insert it into the reserved slot. Make sure that it is properly connected, for which it is necessary to overcome the resistance caused in the connector located in the slot.
- Make the necessary connections in the terminal block or connectors available according to each case.
- For more information, contact our **T.S.S.** or our nearest distributor.

5.2.7. Protection against voltage spikes for the modem / ADSL / fax, etc., line.

-  The communications line -COM- constitutes a very low voltage safety circuit. To preserve the quality must be installed separately from other lines carrying dangerous voltages (power distribution line).
- Connect the main line for the modem / ADSL / fax, etc., to the RJ45 connector of the device, identified as 'Input'.
- Connect the modem / ADSL / fax, etc., to the RJ45 connector of the device, identified as 'Output'.

5.2.8. Software.

Download of free ViewPower software. ViewPower is a UPS monitoring software which provides a user-friendly interface for monitoring and control. It features an auto shutdown function for systems consisting of several PCs in case of power failure. The software enables users to monitor and control any UPS in the same LAN through an RS232 or USB communications port, regardless of how far away they are from each other.

- **Installation procedure:**
 - Go to the web page:
<http://support.salicru.com>
 - Select the required operating system and follow the instructions described on the web page to download the software.

5.2.9. Considerations before start-up with connected loads.

-  It is recommended to charge the batteries for at least 12 hours before using the UPS for the first time.
 - For this, it will be necessary to supply voltage to the device. The battery charger will work automatically.
 - For the battery modules.
For the models with batteries external to the device or backup extension modules, it will be necessary to turn the fuse or circuit breaker of the batteries to 'On'.
- Although the device can operate correctly without charging the batteries for the specified 12 hours, the risk of a prolonged power cut during the first hours of operation and the UPS's available backup time should be assessed.
- Do not start up the device and loads completely until indicated in Chapter 6.
When it is done, however, it should be carried out gradually to avoid possible difficulties, if not at the first start-up.
- If, in addition to the more sensitive loads, it is necessary to connect high-consumption inductive loads, such as for laser printers or CRT monitors, the starting up of these peripherals will need to be taken into account to prevent the device from crashing.

For this type of load considered NON-PRIORITY, a group of programmable sockets is available depending on the model. Depending on the programming of these, the power supply may or may not be affected in the event of mains failure.

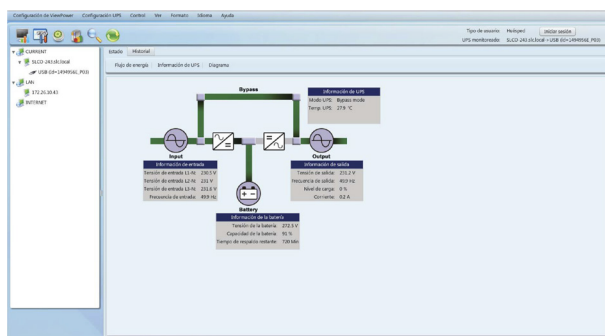

Fig. 12. View of the ViewPower monitoring software's main screen.

6. OPERATION.

6.1. START-UP.

6.1.1. Checks before start-up.

- Make sure that all of the connections have been made correctly, following the instructions on the labelling of the device and in Chapter 5.
- Check that the switch on the battery module or modules is 'Off'.
- Make sure that all loads are 'Off'.



- Shut down the connected loads before starting the UPS and start the loads, one by one, only when the UPS is running. Before shutting down the UPS, check that all of the loads are 'Off'.
- It is very important to proceed in the established order.
- For views of the UPS, see Fig. 1..Fig. 3.

6.2. UPS START-UP AND SHUTDOWN.

6.2.1. UPS start-up with mains voltage.

- Check that the power connection is correct.
- Turn the battery module switch to 'On' (models B0 and B1).
- Supply voltage to the device (turn the input protection on the distribution board to 'On'). If the board has an output switch, turn it to 'On'.
-  All of the models in this series have an input polarity detector (phase-neutral), which activates a modulated audible alarm every 2 seconds and displays the message on the 'SF' display in the event of a fault. When the circumstance arises, disconnect the plug from the mains socket and rotate it 180°. If the same alarm condition is maintained, it will be a two-phase power line signal or installation without neutral referenced to earth. Contact our **T.S.S.** or the distributor before connecting loads to the output.
- The fan or fans, depending on the model, will start to function. Then the main start screen will be displayed after a test of the device.
- Press the ON/MUTE button for more than 2 seconds, the audible alarm will sound for 1 second, the UPS will start up and an automatic battery test lasting 10 seconds will begin.
- After a few seconds, the UPS will be in 'Normal mode'. If the mains voltage is incorrect, the UPS will switch to 'Battery mode', without interrupting the power supply at the output terminals.
- Start the load or loads, making sure that the rated power of the device is not exceeded.

6.2.2. UPS start-up without mains voltage.

- If it has a distribution board, turn the input and output protections to 'On'.
- Turn the battery switch to 'On' (B0 and B1).
- Press the ON/MUTE button for more than 2 seconds, the audible alarm will sound for 1 second and the UPS will start up.

The fan or fans, depending on the model, will start to function.

Then the main start screen will be displayed after a test of the device.

- After a few seconds, the UPS will be in 'Battery mode', meaning that its charge level and therefore available residual backup, as well as the risks associated with operating in this mode, must be taken into consideration. If the mains voltage returns, the UPS will transfer to 'Normal mode' without interrupting the power supply at the output terminals.
- Start the load or loads, making sure that the rated power of the device is not exceeded.

6.2.3. UPS shutdown with mains voltage.

- Shutdown the load or loads.
- Press the OFF/ENTER button for more than 2 seconds to shut down the inverter. The audible alarm will sound for 1 second. The device is in Standby (no output voltage) and charging batteries.

6.2.4. UPS shutdown without mains voltage.

- Shutdown the load or loads.
- Press the OFF/ENTER button for more than 2 seconds to shut down the inverter. The audible alarm will sound for 1 second. The device will leave the output terminals without voltage. A few seconds later, the LCD screen turns off and the entire device will be out of service.
- To leave the assembly completely isolated, turn the input and output switches of the board to 'Off'.

7. CONTROL PANEL WITH LCD DISPLAY.

7.1. GENERAL INFORMATION FOR THE SERIES.

7.1.1. Information represented by the display.

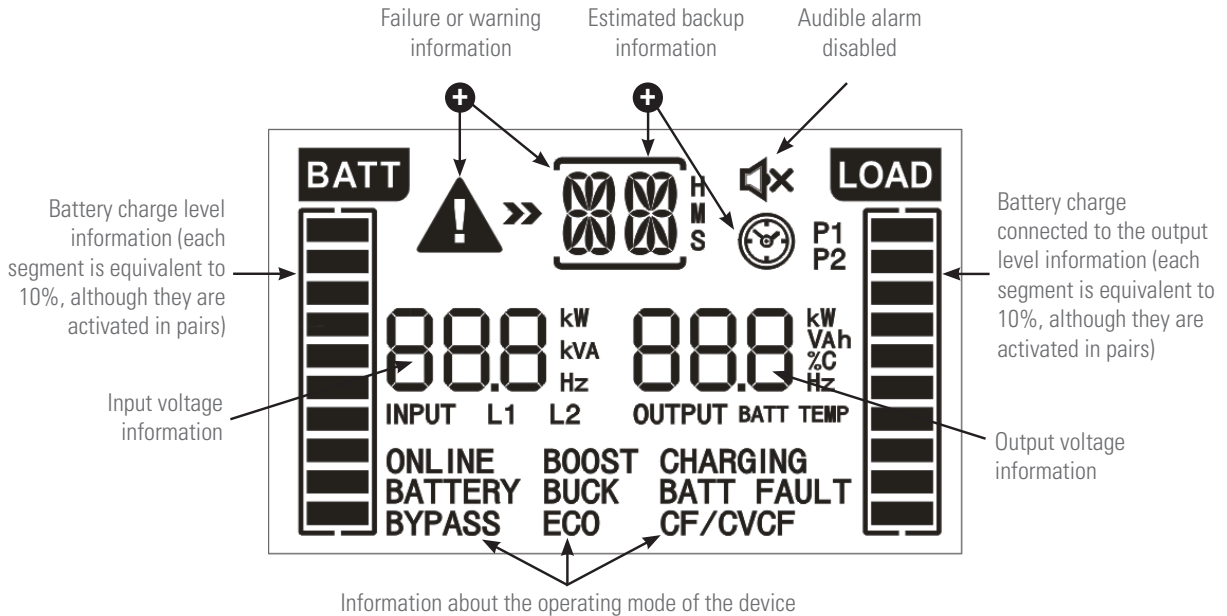

Fig. 13. Graphic and textual information shown on the display.

7.1.2. Other messages shown on the LCD display.

Display	Meaning
Information about programmable outputs	
P1	Indicates that the programmable outputs are activated.
Information about the operating mode of the device.	
BATTERY	Indicates that the device is supplying output voltage from the battery (battery mode).
ECO	Indicates that the device is supplying output voltage from the input (normal mode).
CHARGING	Indicates that the device is in charging mode.
BUCK	Indicates that the device is in buck mode.
BOOST	Indicates that the device is in boost mode.
Information about battery charge level.	
⚠ BATT FAULT	Indicates that the battery is not connected.

Tab. 4. Description of other messages shown on the control panel's LCD display.

7.1.3. Common abbreviations shown on the display.

Code	On display	Meaning
ENA	ENR	Enabled.
DIS	d IS	Disabled.

Code	On display	Meaning
ON	ON	Start-up.
EPO	EP	Emergency power off.
ESC	ESC	Escape.
AO	AO	EPO normally open.
AC	AC	EPO normally closed.
Ok	OK	Ok.
SD	Sd	Shutdown.
BL	bl	Low battery.
OL	OL	Overload.
NC	NC	Battery not connected
OC	OC	Battery overcharge
SF	SF	Connection error. Rotate the connection of the input, phase and neutral cables.
TP	TP	Overtemperature.
CH	CH	Charger

Code	On display	Meaning
BF	BF	Battery failure, low voltage.
BR	BR	Replace batteries.
EE	EE	Internal EEPROM error.

Tab. 5. Abbreviations shown on the LCD display.

7.2. COMPOSITION OF THE CONTROL PANEL WITH LCD DISPLAY.

- The control panel consists of:
 - Three buttons with the functions described in Tab. 6.
 - An LCD display with backlighting.

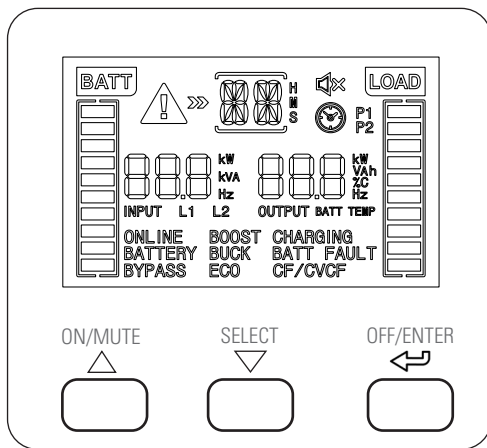

Fig. 14. View of the control panel.

Button	Description
ON/MUTE △	- Starting up the UPS. Press the button for at least 2 seconds.
	- Muting the alarm. Press the button for at least 3 seconds to mute or unmute the audible alarm. It is only possible to mute the battery discharge alarm, which necessarily means that the device is running and operating in battery mode. Any other warning or error alarm cannot be muted.
	- Button to navigate upwards. When this button is pressed in UPS settings mode, it will move upwards through the menu structure in relation to the point where it is located, accessing the previous variable with each press.
	- Activating the battery test. Press this button for 3 seconds while in normal or frequency converter (CF) mode. At the end of the test, it returns to the respective mode.

SELECT ▽	<ul style="list-style-type: none"> - Changing the LCD screen display. Press this button to change the message on the display to read input voltage, input frequency, battery voltage, battery level, ambient temperature, output voltage, output frequency, load consumption and percentage of load consumption. - Settings or configuration mode. Press this button for at least 3 seconds to access this mode when the inverter of the UPS is shut down. - Button to navigate downwards. When this button is pressed in UPS settings mode, it will move downwards through the menu structure in relation to the point where it is located, accessing the following variable with each press.
OFF/ENTER ↶	<ul style="list-style-type: none"> - UPS shutdown. Press this button for at least 2 seconds. - Confirmation of selection. Press this button to confirm selection in the device's settings mode.

Tab. 6. Functionality of the control panel buttons.

7.3. AUDIBLE ALARMS.

Description	Alarm modulation or tone	Possibility of muting
State of the UPS		
Battery mode	Beep every 10 s	Yes
Warning		
Polarity error	Beep every 2 s	Yes
Low battery	Beep every 2 s	
Overload	Beep every 1 s	
Faults		
All	Continuous.	No

Tab. 7. Audible alarms.

7.3.1. Location of the adjustment parameters on the display.

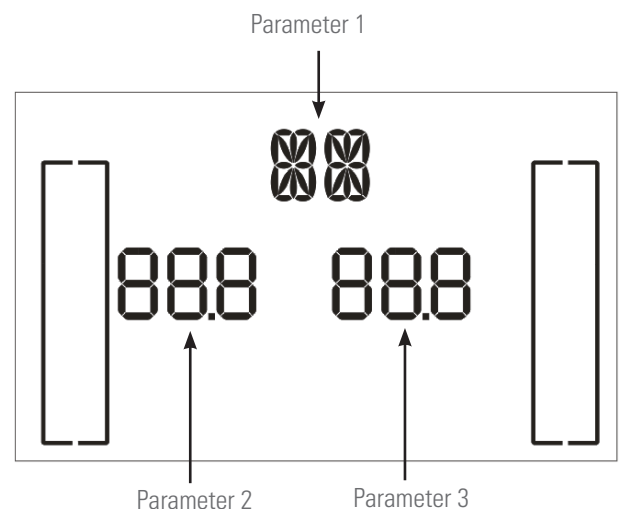



Fig. 15. Arrangement of the parameters on the LCD display.

- Parameter 1:
Adjustable codes. For more information consult Tab. 8.
- Parameters 2 and 3 are the configuration or value options for each settings menu.
 -  Select with buttons '▽' or '△' to modify the menus or parameters.
 -  All of the parameter settings are saved when the UPS is completely shut down and provided that it has connected batteries, whether internal or external. If a complete shutdown is not carried out, the setting will not be saved to the memory.

7.3.2. Settings.

Tab. 8 shows a summary of parameter 1's adjustable codes for each operating mode and Fig. 16 shows the structure of the menu tree with the operating mode for the settings.

Code	Description	Mode		
		No output	AC and batteries	ECO and battery test
01	Output voltage.	YES	-	-
02	Programmable output state.	YES	NO	NO
03	Programmable output configuration.	YES	NO	NO
04	Backup limitation configuration.	YES	NO	NO
05	Battery pack Ah configuration.	YES	NO	NO
06	EPO logical configuration.	YES	NO	-

Tab. 8. Parameter 1 adjustable codes list.

7.3.2.1. Ah configuration of parameter '05'.

- Standard models are configured with factory default settings, so it is not necessary to perform any actions to adjust this parameter.
For extended backup and B1 models, however, it is necessary to adjust the value to the total capacity of the battery pack. Any alteration of the battery pack will entail a readjustment, so it will be necessary to adapt the value in the event of future expansions.
- There are basically two reasons to perform the adjustment without it affecting the correct functioning of the device if it is not done, although it is more than recommended:
 - a. The charging current of the batteries is directly related to the capacity of the battery pack.
The charger will adapt the charging factor automatically according to the value of the total capacity entered, up to the maximum of the current that is possible.
This results in faster charging and therefore greater availability and more immediate backup in the event of frequent mains failures.
 - b. Entering the value in Ah is vital for the control to be able to calculate and show the backup available on the LCD display, without further alterations.

The settings values are determined as follows:

1. Devices with backup extension.
They are configured by a standard model plus the battery module or modules. The capacity of the batteries of both are indicated in the following Tab. 9 and Tab. 10.
Example for an SPS.1500 ADVANCE RT2 and backup extension module 6A0BU000003:
 $7 \text{ Ah} + 14 \text{ Ah} = 21 \text{ Ah}$ (value for parameter 05).

UPS model	Internal batteries	
	Voltage (V)	Capacity (Ah)
SPS.800 ADVANCE RT2	24	7
SPS.1100 ADVANCE RT2		9
SPS.1500 ADVANCE RT2	48	7
SPS.2000 ADVANCE RT2		9
SPS.3000 ADVANCE RT2		

Tab. 9. Characteristics of batteries in standard devices.

Battery module		
Code	Voltage (V)	Capacity (Ah)
6A0BU000001	24	14 (2 x 7)
6A0BU000002		18 (2 x 9)
6A0BU000003	48	14 (2 x 7)
6A0BU000004		18 (2 x 9)
6A0BU000005		

Tab. 10. Characteristics of batteries in modules.

2. Device B1.
B1 models do not have batteries in the same box, so a battery module will always be necessary or the user will have them.
Example for an SLC 1500 ADVANCE RT2 B1 and three backup extension modules 6A0BU000003:
 $(3 \times 14 \text{ Ah}) = 42 \text{ Ah}$ (value for parameter 05).

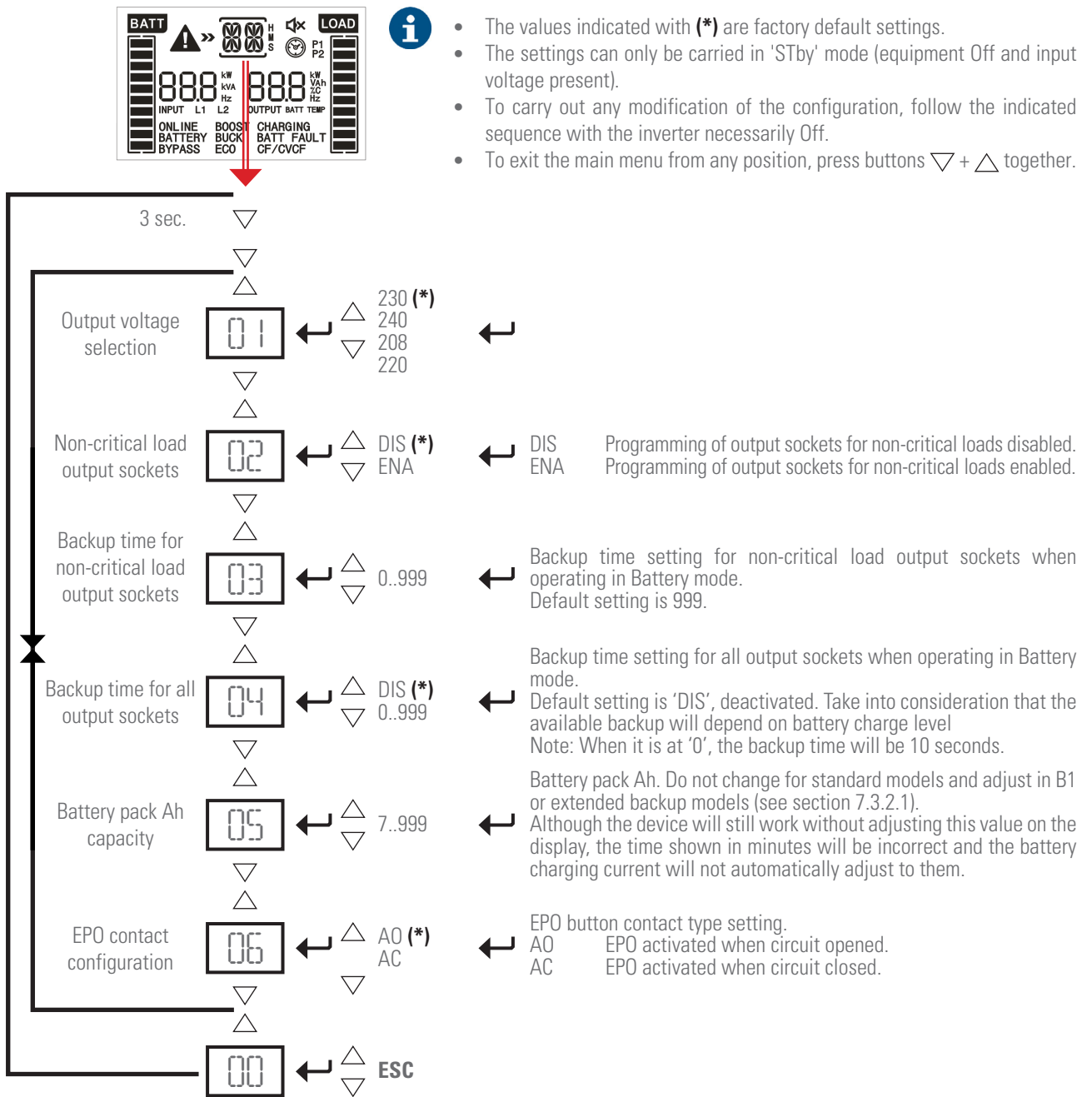
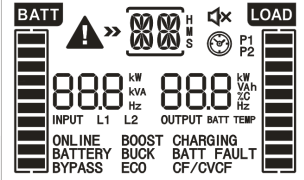
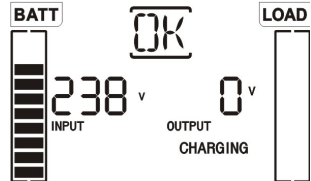

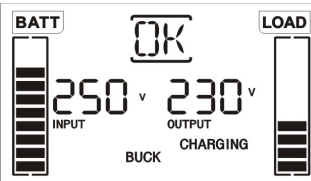
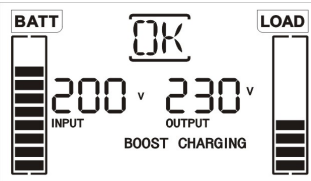
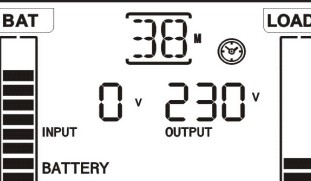
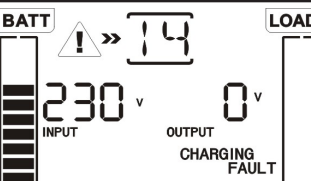

Fig. 16. Settings menu.

7.3.2.2. Operating mode / Description of state.

Operating mode / state	
	Description. When the UPS is started, the display screen of this mode is displayed for a few seconds to initialise the CPU and system.
UPS start-up	LCD display. 

Operating mode / state		
No output mode	Description.	The UPS is off and no output voltage is available, but it is charging the batteries.
	LCD display.	
ECO mode	Description.	If the input voltage is within the regulation ranges, the UPS supplies the output voltage from the normal mode input.
	LCD display.	
BUCK mode	Description.	If the input voltage is above the output regulation range, but within the input range, the UPS supplies output voltage from BUCK mode.
	LCD display.	
BOOST mode	Description.	If the input voltage is below the output regulation range, but within the input range, the UPS supplies output voltage from BOOST mode.
	LCD display.	
Battery mode	Description.	Description: When the input / frequency voltage is not within the predefined range of the device or there is an AC mains failure, the UPS powers the loads from the batteries for a limited time due to their own capacity and activates the audible alarm modulated every 5 seconds.
	LCD display.	
Error or fault state	Description.	When an error occurs, the ERROR icon and the fault code are displayed.
	LCD display.	

Tab. 11. Operating modes.

7.3.2.3. Warning or alert codes and indicators.

Code	Description	Icon (flashing)	Audible alarm
bL	Low battery		Modulated every 2 s
OL	Overload		Modulated every 1 s
NC	Battery not connected		Modulated every 2 s
OC	Battery overcharge		Modulated every 2 s
SF	Input socket connection fault		Modulated every 2 s
EP	EPO enabled		Modulated every 2 s
TP	Overtemperature		Modulated every 2 s
CH	Charger fault		Modulated every 2 s
bF	Battery fault		Modulated every 2 s (The UPS disconnects to warn the user that the batteries are incorrect).
bR	Replace batteries		Modulated every 2 s
EE	EEPROM error		Modulated every 2 s

Tab. 12. Warning or alert code.

7.3.2.4. Error or fault codes.

Code	Error or fault description
01	DC bus start-up fault.
02	DC bus overvoltage.
03	DC bus undervoltage.
11	Inverter soft start fault
12	High voltage in the inverter
13	Low voltage in the inverter
14	Inverter output short-circuited
27	Battery voltage too high
28	Battery voltage too low
41	Overtemperature
43	Output overload
45	Charger fault

Tab. 13. Error or fault code.

8. MAINTENANCE, WARRANTY AND SERVICE.

8.1. BATTERY MAINTENANCE.

- Pay attention to all of the safety instructions concerning batteries indicated in section 1.2.3 of manual EK266*08.
- The service life of the batteries greatly depends on the ambient temperature and other factors such as the number of charges and discharges, as well as their depth. The service life is designed to be between 3 and 5 years if the ambient temperature is between 10 and 20°C. Different types of battery with different service lives are available upon request.
- SPS.ADVANCE RT2 series UPSs require minimum upkeep. The batteries used in the standard models are lead acid, sealed, valve regulated and maintenance free. The only requirement is to charge the batteries regularly to extend their life expectancy. While it is connected to the mains supply, whether or not it is running, it will keep the batteries charged and also offer protection from overcharging and deep discharge.

8.1.1. Notes for the installation and replacement of the battery.

- If it is necessary to replace any connection cables, original materials can be purchased through our **T.S.S.** or authorised distributors. Using inappropriate cables can lead to overheating in connections, which is a fire hazard.
-  Inside the device, there are permanent dangerous voltages even without mains supply present through its connection with the batteries and especially in UPSs where the electronics and batteries share a box. Also take into consideration that the battery circuit is not isolated from the input voltage, so there is a risk of discharge with dangerous voltages between the battery terminals and the earth terminal, which is in turn connected to earth (any metal part of the device).
- Repair and/or maintenance work must be carried out by our **T.S.S.**, except for the replacement of batteries, which can be performed by qualified personnel familiar with them. No other person should handle them. Depending on the configuration of the UPS, certain actions need to be carried out before handling the batteries:
 - Devices with batteries and electronics sharing the same box.
 - Shut down the loads and device completely.
 - Disconnect the SPS.ADVANCE RT2 from the mains.
 - Open the device to access the interior.
 - Remove the fuse or internal battery fuses.
 - Release the battery holders and replace the batteries.
 - Perform the above steps in reverse to return the device to how it was at the start, including start-up.
 - UPS with batteries and electronics in separate boxes.
 - Shut down the loads and device completely.
 - Disconnect the SPS.ADVANCE RT2 from the mains.
 - Disconnect the battery module from the UPS.
 - Open the battery module to access the interior.
 - Remove the fuse or internal battery fuses.

- Release the battery holders and replace the batteries.
- Perform the above steps in reverse to return the device to how it was at the start, including start-up.

8.2. UPS TROUBLESHOOTING GUIDE.









If the UPS does not work properly, check the information shown on the LCD screen of the control panel and act accordingly depending on the device model.

Using the Tab. 14 troubleshooting guide, try to resolve the issue and, if it persists, consult our Technical Service and Support **T.S.S.**

If it is necessary to contact our Technical Service and Support **T.S.S.**, provide the following information:

- UPS model and serial number.
- Date on which the issue occurred.
- Full description of the issue, including information provided by the LCD display or LEDs and state of the alarm.
- Power supply conditions, type of load and level of load applied to the UPS, ambient temperature, ventilation conditions.
- Battery information (capacity and number of batteries), whether the device is a (B0) or (B1).
- Any other information considered relevant.

- Troubleshooting guide.

Symptom	Possible cause	Solution
No alarms or indications on the LCD display and mains voltage normal.	The power cable is not connected correctly.	Check that the power cables are firmly connected to the mains.
	The power cable is connected to an IEC output connector on the UPS.	Correctly connect the power cable to the respective IEC connector.
Icon  and warning code  flash on the LCD display and the audible alarm modulated every two seconds is active.	The EPO function is activated.	Close the EPO signal circuit to deactivate it.
Icon  and warning code  flash on the LCD display and the audible alarm modulated every two seconds is active.	Neutral earth fault detection. Inverted phase and neutral input cables.	Disconnect the input plug from the AC power socket and invert the connection of the phase and the supply neutral (rotate the plug 180°).
Icon  and warning code  flash on the LCD display and the audible alarm modulated every two seconds is active.	The internal or external batteries are badly connected	Check that all batteries are properly connected.
Fault code 27 and the BATT FAULT message are shown on the LCD display. The alarm sounds continuously.	The voltage of the batteries is too high or the charger is faulty.	Contact the distributor or seller or, failing that, our T.S.S.
Fault code 28 and the BATT FAULT message are shown on the LCD display. The audible alarm sounds continuously.	The voltage of the batteries is too low or the charger is faulty.	Contact the distributor or seller or, failing that, our T.S.S.
Icon  , LOAD and warning code  flash on the LCD display and the audible alarm modulated every second is active.	The UPS is overloaded.	Disconnect the excess loads from the output sockets.
Fault code 43 is shown on the LCD display. The audible alarm sounds continuously.	The UPS shuts down automatically as a result of an overload in the output of the device.	Disconnect the excess loads from the output sockets and restart it.
Fault code 14 is shown on the LCD display. The audible alarm sounds continuously.	The UPS shuts down automatically as a result of a short circuit in the output.	Check the output wiring and that the connected loads are not short-circuited
Fault codes 01, 02, 03, 11, 12, 13 and 41 are shown on the LCD display. The audible alarm sounds continuously.	An internal fault has occurred in the UPS.	Contact the distributor or seller or, failing that, our T.S.S.
The backup time is shorter than expected.	The batteries do not charge completely.	Charge the batteries for at least 5 h and then check their charge state. If the problem persists, contact the distributor or seller or, failing that, our T.S.S.
	Faulty batteries.	Contact the distributor or seller or, failing that, our T.S.S. for battery replacement.
Fault code 45 is shown on the LCD display. At the same time, the audible alarm sounds continuously.	The charger does not provide output and the battery voltage is less than 10 V per element.	Contact the distributor or seller or, failing that, our T.S.S.

Tab. 14. Troubleshooting guide.

8.3. WARRANTY CONDITIONS.

8.3.1. Terms of the warranty.

On our website you will find the warranty conditions for the product you have purchased where you can also register it. It is recommended to do so as soon as possible to include it in the database of our Technical Service and Support (**T.S.S.**). Among other advantages, it will streamline any regulatory procedures for the intervention of **T.S.S.** in the event of a fault.

8.3.2. Exclusions.

Our company will not be bound by the warranty if it notices that the defect in the product does not exist or was caused by improper use, negligence, improper installation and/or verification, attempts at unauthorized repair or modification, or any other cause beyond the intended use, or by accident, fire,

lightning or other hazards. Nor shall it cover any compensation for damages.

8.4. TECHNICAL SERVICES NETWORK.

Information about our national and international Technical Service and Support (**T.S.S.**) centres can be found on our website.

9. ANNEXES.

9.1. GENERAL TECHNICAL SPECIFICATIONS.

Models.	ADVANCE RT2.				
Available power ratings (VA / W).	800 / 720	1,100 / 990	1,500 / 1,350	2,000 / 1,800	3,000 / 2,700
Technology.	Line-interactive with sine-wave output.				
Input.					
Input type.	Single-phase.				
Number of cables.	3 cables - Phase R (L) + Neutral (N) and earth.				
Rated voltage.	208 / 220 / 230 / 240 V AC ⁽¹⁾				
Input voltage range.	176.. 288 V AC				
Input frequency range.	45.. 55 / 55.. 65 Hz \pm 0.2 Hz; auto-detectable.				
Permissible power factor loads.	0.9				
Cold start (from batteries).	Yes, by default with frequency of 50 Hz.				
Inverter.					
Technology.	PWM				
Waveform.	Pure sine wave.				
Power factor.	0.9				
Rated voltage.	208 / 220 / 230 / 240 V AC ⁽¹⁾ , selectable				
Output voltage accuracy (battery mode).	\pm 1.5 %				
Total harmonic distortion (THDv), with linear load.	< 2 %				
Frequency.	With mains present, synchronised to rated input (45.. 55 / 55.. 65 Hz). With mains absent -backup mode- 50 / 60 \pm 0.1 Hz.				
Transfer time, line mode to battery mode (normal mode).	2..6 ms				
Performance at full load, in normal mode with battery 100% charged.	> 97 %				
Performance at full load, in battery mode.	> 89 %	> 90 %	> 91 %	> 92 %	> 92 %
Overload in line mode	103.. 120 %: 5 min > 120.. 150 %: 10 s > 150 %: 1 s				
Overload in battery mode.	103.. 120 %: 1 min > 120.. 150 %: 10 s > 150 %: 0.5 s				
Crest factor.	3:1				
Batteries (AGM sealed 3 - 5 years life).					
Element voltage.	12 V DC				
Capacity.	7 Ah	9 Ah	7 Ah	9 Ah	9 Ah
Number of batteries in device connected in series / group voltage.	2 / 24 V DC		4 / 48 V DC		6 / 72 V DC
Number of accumulators in battery module connected in series x no. packs in parallel / group voltage.	2 x 2 / 24 V DC		4 x 2 / 48 V DC		6 x 2 / 72 V DC
Low battery voltage.	22.4 V DC		44.8 V DC		67.2 V DC
Blocking voltage for group end of backup.	19.2 V DC		38.4 V DC		57.6 V DC
Internal battery charger.					
Group floating voltage.	27.2 V DC		54.4 V DC		81.6 V DC
Maximum charge current.	1.5 A				
Recharge time.	8 hours to 90%		4 hours to 90%	3 hours to 90%	4 hours to 90%
Optional internal battery charger (B1).					
Maximum charge current.	8 A				
Other functions.					
Cold start.	Yes				
Emergency power off (EPO).	Yes				
IEC output sockets programmable at disconnection, for non-critical loads.	Yes				
General.					
IEC input connectors.	10 A IEC 14 connector.			16 A IEC 20 connector.	
IEC output connectors.	8 x 10 A IEC 13 (4 for critical loads + 4 for non-critical loads programmable at disconnection) + 1 x 16 A IEC 19 (only in 3 kVA model)				
Communication ports.	2 (1 x RS232 -DB9- and 1 x USB, mutually exclusive).				
Potential-free contacts.	Yes, using optocouplers in the same connector as the RS232.				
Connectors with protection for ADSL/fax/modem.	RJ45 connectors, 1 input and 1 output.				

Models.	ADVANCE RT2.					
Available power ratings (VA / W).	800 / 720	1,100 / 990	1,500 / 1,350	2,000 / 1,800	3,000 / 2,700	
Connector for external EPO installation	Yes					
Slot for optional cards.	Yes					
Optional cards (to insert in slot).	Interface to relays (AS400), SNMP, remote Internet or intranet management, MODBUS					
Monitoring software.	ViewPower (free download).					
Audible noise at 1 m in battery mode.	< 45 dB				< 50 dB	
Working temperature.	0.. +40 °C					
Storage temperature with batteries.	-20.. +50 °C					
Storage temperature without batteries.	-20.. +70 °C					
Working altitude.	2,400 masl (power degradation up to 5,000 m)					
Relative humidity.	10.. 95 % non-condensing.					
Protection rating.	IP20					
Dimensions (mm) Depth × Width × Height.	Standard UPS module.	410 x 438 x 88 (2 U)		510 x 438 x 88 (2 U)	630 x 438 x 88 (2 U)	
	UPS module B1.	410 x 438 x 88 (2 U)				
Weight (kg).	Optional battery module.	410 x 438 x 88 (2 U)		510 x 438 x 88 (2 U)	630 x 438 x 88 (2 U)	
	Standard UPS module.	12.9	13.4	19.5	21.5	29.3
	UPS module B1.	9		11		11.9
	Optional battery module.	14.4	16.2	24.7	28.4	40.6
Safety.	EN-IEC 62040-1					
Electromagnetic compatibility (EMC).	EN-IEC 62040-2 (C2)					
Operation.	EN-IEC 62040-3					
Marking.	CE					
Quality system.	ISO 9001 and ISO 140001					

⁽¹⁾ 80 % power reduction for 208 V devices.

Tab. 15. General technical specifications.

9.2. GLOSSARY.

- **AC.-** Alternating current is electric current in which the magnitude and direction vary cyclically. The waveform of the most commonly used alternating current is that of a sine wave, since this achieves a more efficient transmission of energy. In certain applications, however, other periodic waveforms are used, such as triangular or square.
- **Bypass.-** Manual or automatic, this is the physical connection between the input of an electrical device and its output.
- **DC.-** Direct current is the continuous flow of electrons through a conductor between two points with different potential. Unlike AC, in DC, electrical loads always circulate in the same direction from the point of greatest potential to the lowest. Although DC is commonly identified as a continuous current (for example, that supplied by a battery), any current that always maintains the same polarity is continuous.
- **DSP.-** Digital signal processor. A DSP is a processor or microprocessor-based system that has a set of instructions, hardware and optimised software for applications that require numerical operations at very high speed. Because of this, it is especially useful for the processing and representation of analogue signals in real time: in a system that works in this way (real time) samples are usually received from an analogue/digital converter (ADC).
- **Power factor.-** The power factor, PF, of an AC circuit is defined as the ratio between active power, P, and apparent power, S, or as the cosine of the angle formed by the current and voltage factors, designated in this case as $\cos \phi$, where ϕ is the value of the angle.
- **GND.-** This stands for GROUND or EARTH and, as the name indicates, refers to the potential of the surface of the Earth.
- **EMI filter.-** Filter capable of significantly reducing electromagnetic interference (EMI), which is the disturbance that occurs in a radio receiver or in any other electrical circuit caused by electromagnetic radiation coming from an external source. Electromagnetic interference is also known as radio frequency interference (RFI). This disturbance can interrupt, degrade or limit the performance of the circuit
- **IGBT.-** An insulated gate bipolar transistor is a semiconductor device that is generally used as a controlled switch in power electronics circuits. This device possesses the characteristics of the gate signals of field effect transistors with the capacity for high current and low saturation voltage of the bipolar transistor, combining an isolated FET gate for input and control and a bipolar transistor as a single switch in a single device. The IGBT's excitation circuit is similar to that of the MOSFET, while the conducting characteristics are similar to those of the BJT.
- **Interface.-** In electronics, telecommunications and hardware, an interface (electronics) is the port (physical circuit) through which signals are sent or received from one system or subsystem to another
- **kVA.-** A volt-ampere is the unit used for apparent power in electrical current. In DC, it is practically equal to real power but, in AC, it can differ from this depending on the power factor.
- **LCD.-** Liquid crystal display, a device invented by Jack Janning, who was an employee of NCR. It is an electrical system for data presentation formed by 2 transparent conductive layers and a special crystalline material in the

middle (liquid crystal) which have the ability to orientate light as it passes through.

- **LED.-** Light-emitting diode, a semiconductor device (diode) that emits light that is almost monochromatic, that is to say, it has a very narrow spectrum when it is polarised directly and is penetrated by an electric current. The colour (wavelength) depends on the semiconductor material used in the construction of the diode, and can vary from ultraviolet, passing through the visible light spectrum, to infrared, the latter called IRED (infra-red emitting diode).
- **Circuit breaker.-** A circuit breaker is a device capable of interrupting the electrical current of a circuit when it exceeds certain maximum values.
- **On-line mode.-** A device is said to be on-line when it is connected to a system, is operative, and normally has its power supply connected.
- **Inverter.-** An inverter is a circuit used to convert DC into AC. The function of an inverter is to change a DC input voltage to a symmetrical AC output voltage, with the magnitude and frequency desired by the user or designer.
- **Rectifier.-** In electronics, a rectifier is the element or circuit that converts AC into DC. This is done by using rectifier diodes, whether solid state semiconductors, vacuum valves or gaseous valves, such as those containing mercury vapour. Depending on the characteristics of the AC power that they use, they are classified as single-phase when they are powered by a mains phase or three-phase when they are powered by three phases. Depending on the type of rectification, they can be half wave when only one of the half cycles of the current is used or full wave when both half cycles are used.
- **Relay.-** A relay is an electromechanical device that functions as a switch controlled by an electrical circuit in which, by means of an electromagnet, a set of one or several contacts is activated to enable other independent electrical circuits to be opened or closed.
- **SCR.-** Silicon controlled rectifier, commonly known as a thyristor, a 4-layer semiconductor device that works as an almost ideal switch.
- **THD.-** Total harmonic distortion. Harmonic distortion occurs when the output signal of a system does not equal the signal that entered it. This lack of linearity affects the waveform because the device has introduced harmonics that were not in the input signal. Since they are harmonic, that is to say, multiples of the input signal, this distortion is not so dissonant and is less easy to detect.



A series of horizontal dotted lines spanning the width of the page, providing a template for writing or notes.

SALICRU

Avda. de la Serra 100

08460 Palautordera

BARCELONA

Tel. +34 93 848 24 00

services@salicru.com

SALICRU.COM



The Technical Service and Support (T.S.S.) network, Commercial network and warranty information are available in website:

www.salicru.com

Product Range

Uninterruptible Power Supplies (UPS)

Lighting Flow Dimmer-Stabilisers

DC Power Systems

Static Inverters

Photovoltaic Inverters

Voltage stabilisers



@salicru_SA



www.linkedin.com/company/salicru

