



Photon Mono X 6Ks

 [User Manual](#)

Dear customer,

Thank you for choosing Anycubic products.

Maybe you are familiar with 3D printing technology or have purchased Anycubic printers before. However, we still highly recommend you read this manual carefully, as the installation techniques and precautions can help you avoid any unnecessary damage or frustration.

Please visit <https://support.anycubic.com> to contact us if you have any questions. You can also learn more information from the website, such as software, videos, models.



Anycubic support center

Copyrighted by "Shenzhen Anycubic Technology Co., Ltd ", all rights reserved.

Team Anycubic

Safety Instructions

Always follow the safety instructions during assembly and usage, to avoid unnecessary damage to the 3D printer or individual injury.



Please contact our Customer Service if you have any issues after receiving the products.



Be cautious when using the scraper. Never direct the scraper towards your hands.



In case of emergency, please immediately cut off the power of the 3D printer and contact our technical support.



Anycubic 3D printer includes components that can cause injury.



It is recommended to use protective glasses when sanding the printed models to avoid eye contact with small particles.



Keep the Anycubic 3D printer and its accessories out of the reach of children.



Vapors or fumes may be irritating at operating temperatures. Always use the Anycubic 3D printer in an open and well ventilated area.



Do not expose Anycubic 3D printer to any water or rain environment.



Use Anycubic 3D printer in an environment with a temperature of 8°C-40°C and a humidity of 20%-50%. For optimal performance, do not exceed this range. Also, avoid direct sunlight exposure.



Do not disassemble Anycubic 3D printer, please contact technical support if you have any questions.



Contents

1. Product Overview	5
2. In the Box	6
3. Technical Specification	7
4. Recommended Print Parameters	8
5. Menu Directory	10
6. Preparations	13
7. Print Test	15
8. Resin Exposure Range Finder	17
9. FAQ	19
10. Machine Maintenance	20

Product Overview

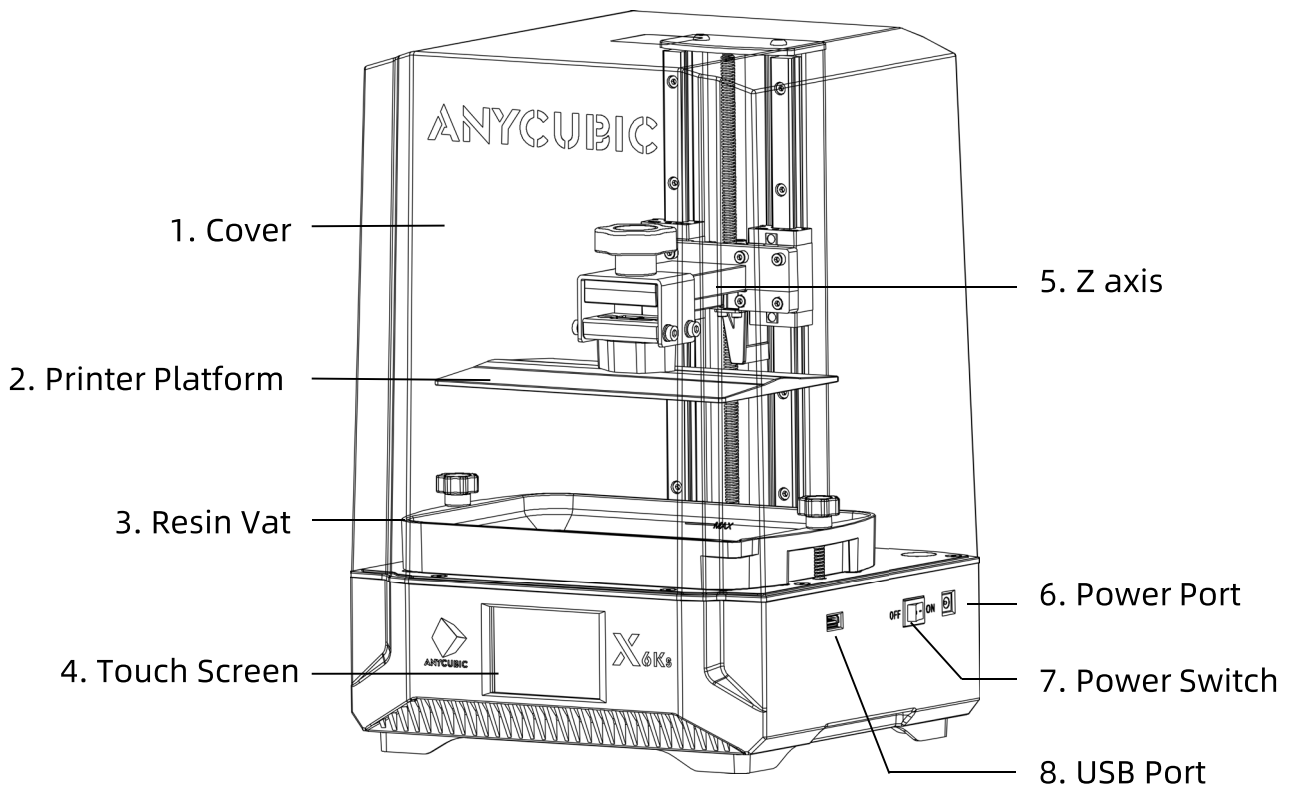

In the Box

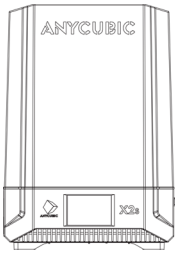

Photon Mono X 6Ks

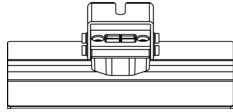

Print platform *1



Resin vat *1



Hex key set



USB drive *1

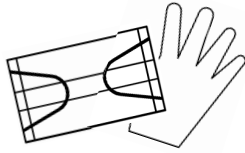

Protective equipment

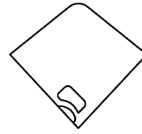

Funnel *2

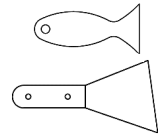

Scraper *2

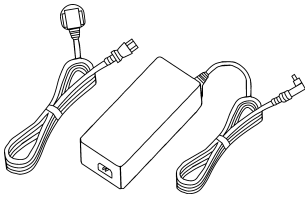

Power adaptor
Power cord

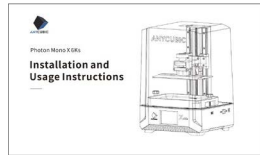

Manual *1

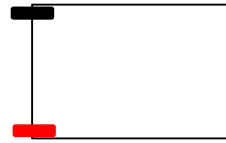

Screen protector kit



Leveling paper *1

Operating System

System	Photon Mono X 6Ks
Touch Screen	3.5-inch Resistive Screen
Software	Anycubic Photon Workshop
Connectivity	USB Drive

Specifications

LCD screen	9.1 inch 6K
Light source	Matrix LED light
XY Resolution	5760*3600
Z axis Accuracy	0.01 mm
Suggested Layer Thickness	0.01 ~ 0.15 mm

Physical Dimensions

Dimension	290 mm(L) *260 mm(W) *417 mm(H)
Build volume	195 mm(L) *122 mm(W) *200 mm(H)
Weight	8.5 kg

Recommended Print Parameters

1. Basic Resin-Clear/Translucent Green

Model accuracy	Regular					High-accuracy
Layer Thickness (mm)	0.01~0.02	0.03~0.04	0.05	0.1	0.15	0.05
Normal Exposure Time (s)	2	2.25	2.5	3	4	2.5
Off Time (s)	0.5					
Bottom Exposure Time (s)	20					
Bottom Layers	5					
Anti-alias	1					
Z Lift Distance (mm)	8					
Z Lift Speed (mm/s)	2					
Z Retract Speed (mm/s)	3					

2. Basic Resin-Gray

Model accuracy	Regular					High-accuracy
Layer Thickness (mm)	0.01~0.02	0.03~0.04	0.05	0.1	0.15	0.05
Normal Exposure Time (s)	2	2.25	2.5	3	4	2.25
Off Time (s)	0.5					
Bottom Exposure Time (s)	20					18
Bottom Layers	5					
Anti-alias	1					
Z Lift Distance (mm)	8					
Z Lift Speed (mm/s)	2					
Z Retract Speed (mm/s)	3					

--The data above root in Anycubic lab, only for reference.

Recommended Print Parameters

3. DLP Craftsman Resin

Model accuracy	Regular					High-accuracy
Layer Thickness (mm)	0.01~ 0.02	0.03~ 0.04	0.05	0.1	0.15	0.05
Normal Exposure Time (s)	2.25	2.5	3	4	5	2.75
Off Time (s)	0.5					
Bottom Exposure Time (s)	20					18
Bottom Layers	5					
Anti-alias	1					
Z Lift Distance (mm)	8					
Z Lift Speed (mm/s)	2					
Z Retract Speed (mm/s)	3					

--The data above root in Anycubic lab, only for reference.

Menu Directory

Home menu

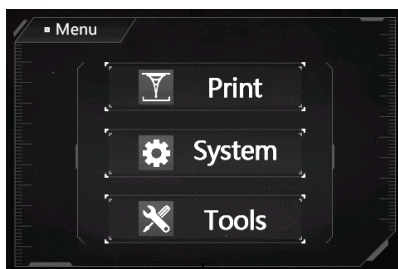

Print

System

Tools

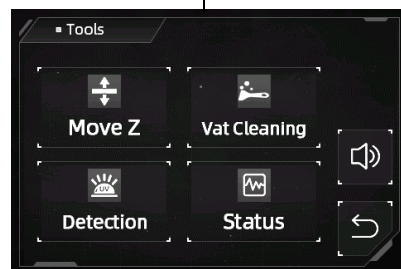
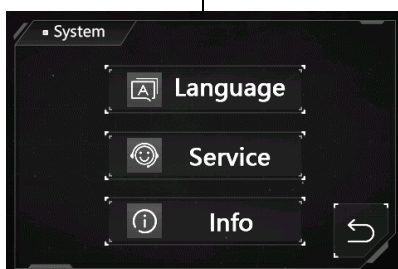

Print

Choose Files:



File

Click a file

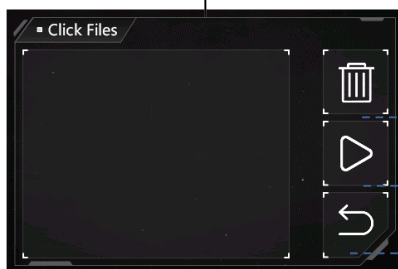

System

Language: Switch to English/Chinese

Service:

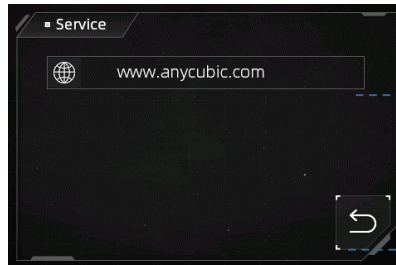

Official website

Return to the System Menu

Information:

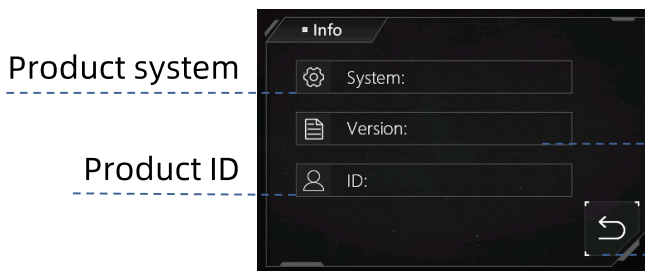

Product system

Product ID

System version

Return to the System Menu

Tools

Move Z:

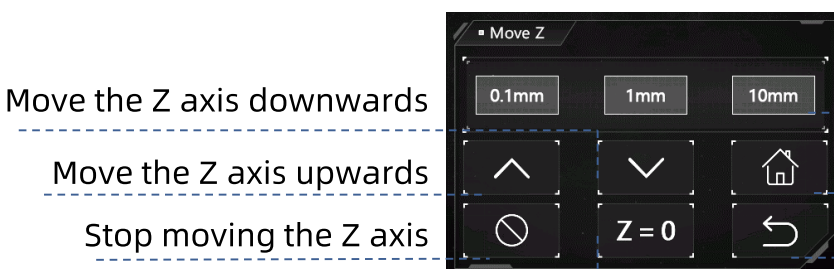

Move the Z axis downwards

Move the Z axis upwards

Stop moving the Z axis

Move Z by 0.05mm
/1mm/10mm/50mm

Return to Zero

Return to the Tools Menu

Reset the zero point

Vat Cleaning:



The screenshot shows the 'Vat Cleaning' menu with a horizontal slider for exposure time. The slider has markers for 10s, 20s, 30s, 40s, and 50s. The 30s marker is currently selected. Below the slider is a 'Start' button and a back arrow icon.

Click to start exposure

Set the exposure time

Return to Tools Menu

Exposure :

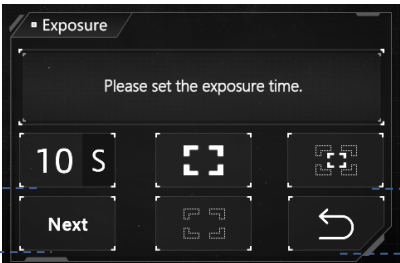

The screenshot shows the 'Exposure' menu with the text 'Please set the exposure time.' at the top. Below this, there are several options: '10 S', a square icon with a crosshair, a square icon with a grid, a 'Next' button, another square icon with a crosshair, and a back arrow icon.

Click to set the time

Expose for the preset time

Choose an image to expose

Return to the Tools Menu

Status:

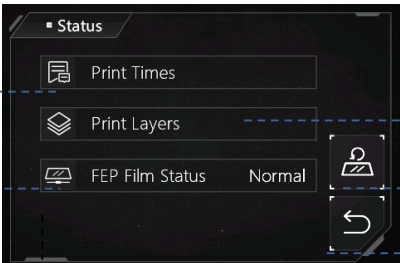

The screenshot shows the 'Status' menu with three main sections: 'Print Times', 'Print Layers', and 'FEP Film Status'. The 'FEP Film Status' section shows 'Normal' next to a film icon. There is also a person icon and a back arrow icon.

Statistics of print times

Whether release film needs to be replaced

Statistics of print layers

Click to reset the status

Return to Tools Menu

Horn icon: Turn on/off the screen sound

Preparations

1. Plug in power and turn on the machine. Raise Z axis by 50mm.

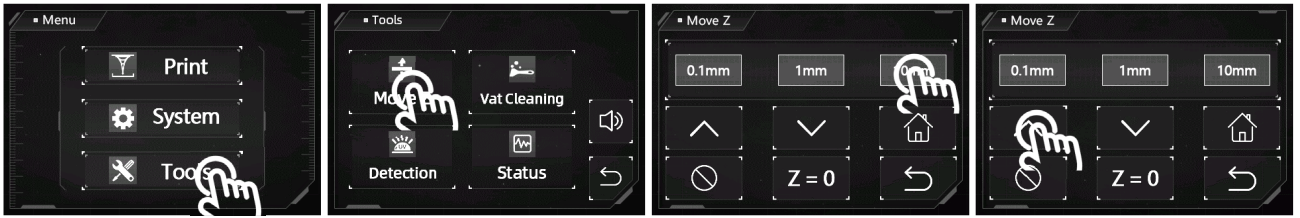

Click 5 times

2. Install the print platform.

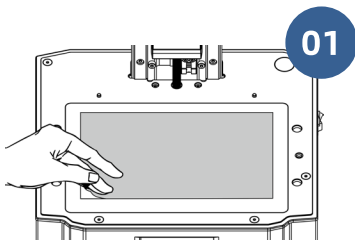

Peel off the protective film

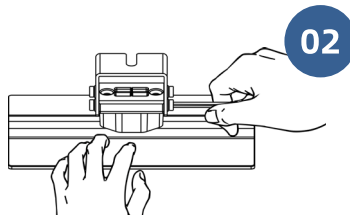

Loosen the four screws on the platform

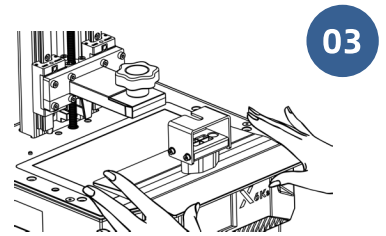

Push the platform onto the platform carrier

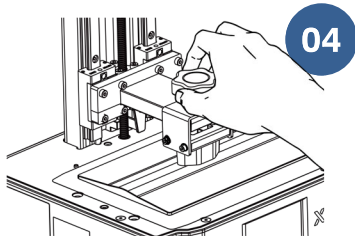

Tighten the knob

3. Leveling.

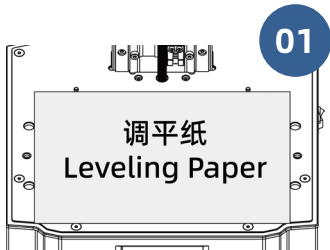

Place the leveling paper on the curing screen

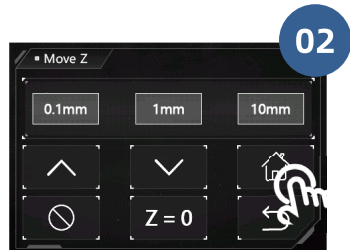

Click "HOME"

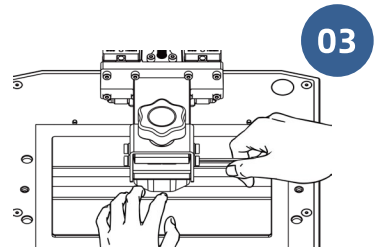

Press the platform gently, tighten the four screws

Preparations

4. Set the zero position.

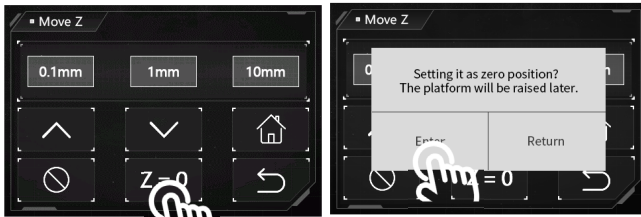

5. Choose an exposure image to test after the platform stops moving.



The white part is exposure area

6. Install the resin vat.

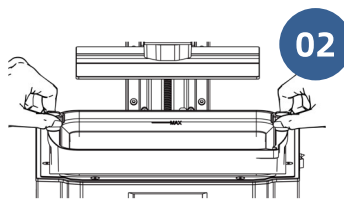
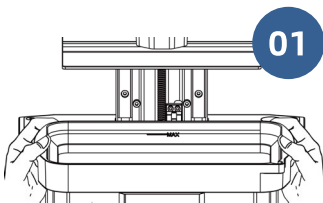

Put the resin vat with its feet stuck in the locating holes

Tighten two knobs

Print Test

*The release film on the resin vat is consumable. Please pay attention to the status of release film on the touch screen and replace the film timely.

Please check the release film carefully before and after every printing. If the film is broken, replace it immediately to avoid further damage to the machine.

1. Make sure you wear masks and gloves (to avoid direct skin contact with resin), slowly pour resin into the vat with **resin level not exceeding the vat's maximum scale**.

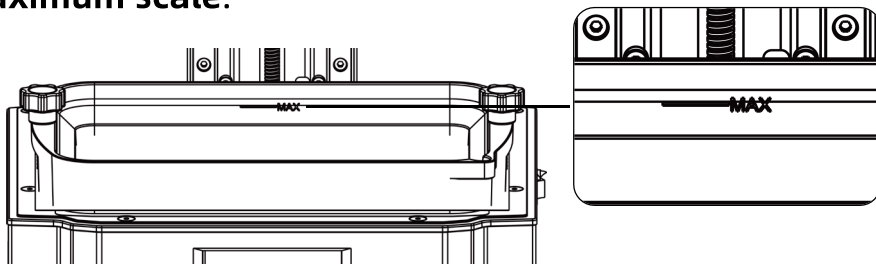

2. Put on the cover. Then, insert the USB drive and print the test file.

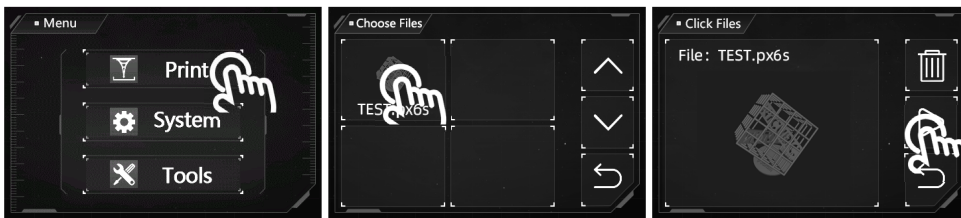

3. When the printing is finished, resin may be cured partly in the vat. Please set to Vat Cleaning and remove the residue.

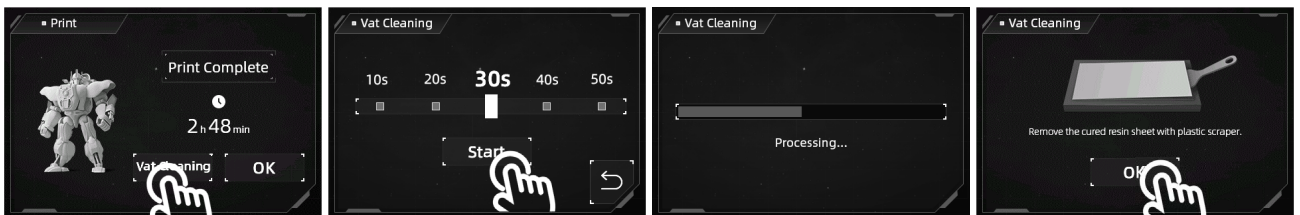

Remove resin sheet
by plastic scraper

Notes:

- ① It's recommended that use the USB drive we provide. Otherwise, please use a USB drive whose memory size **does not exceed 32G** and ensure that it's formatted to **FAT/FAT 32**.
- ② The print files should be placed at the root directory of USB drive to avoid read errors.

TIPS for slice settings

To improve the success rate of printing, the bottom exposure time is always longer. The longer exposure time makes the bottom of print object thicker.

To avoid the thick bottom of print object, please rise the model by 5 mm before you add supports or raft to it in the slice software.

Anycubic Photon Workshop slice software instructions is saved in USB drive.

Finishing

- After printing, remove the platform when resin stop dropping from the platform. Remove the model by metal scraper and then wash it with 95% alcohol or other detergent. It may need post-curing to achieve better hardness by being exposed directly to sunlight or a UV-curing machine.
- After printing, there might be some cured resin left in the vat. Please clean the vat timely, and filter the remaining resin by a funnel. Otherwise, it may cause damage to the release film or LCD screen. If you do not use the resin now, it is recommended to store it in an airtight container away from light.

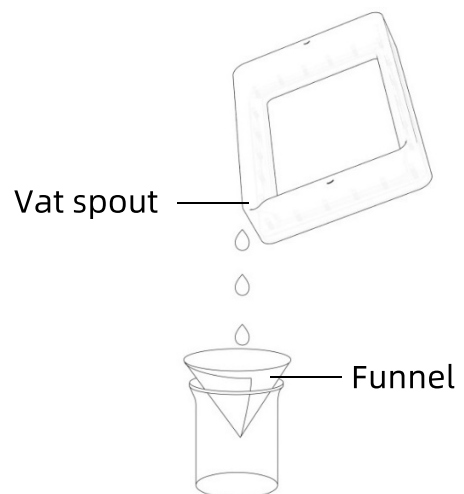
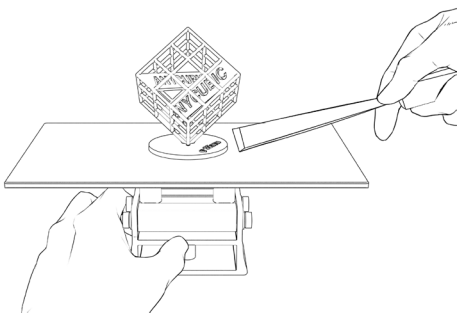

Resin Exposure Range Finder

“R_E_R_F” is an abbreviation for “Resin Exposure Range Finder”. This function is used to find out the optimal exposure parameters for different resins.

1. Import the R_E_R_F file which is saved on USB drive into the slicing software. There are eight models in the file. The exposure time for model 1 is equal to "normal exposure time (s)" of the file, and the exposure time for other models will be increased by an increment of **0.25 s**.

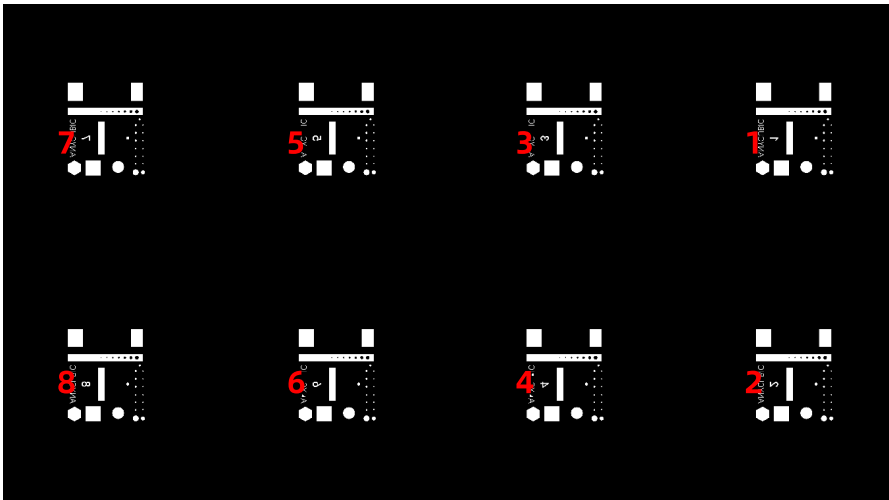

The numbers on the models indicate their order

2. According to the personal requirement, adjust the exposure time of the models by modifying "normal exposure time (s)" of the file. When exposure time for Model No. 1 is changed, the exposure time for other models will be increased by an increment of **0.25 s**.

For example, when normal exposure time is set to 1.5 s, the exposure time for Model No.1-8 is: 1.5 / 1.75 / 2 / 2.25 / 2.5 / 2.75 / 3 / 3.25 s.

3. After printing, remove and clean the models. Compare the print effect of models and choose the model's exposure time that meets your needs as the print parameter. Take a comparison of model A&B as an example.

Resin Exposure Range Finder

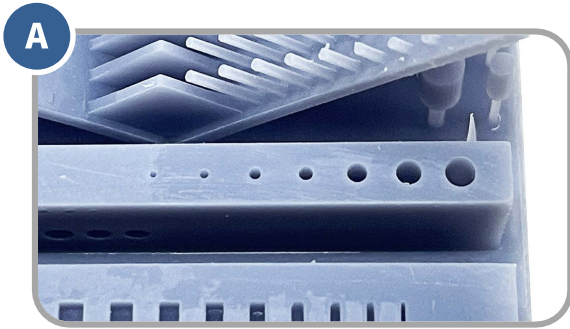

More holes

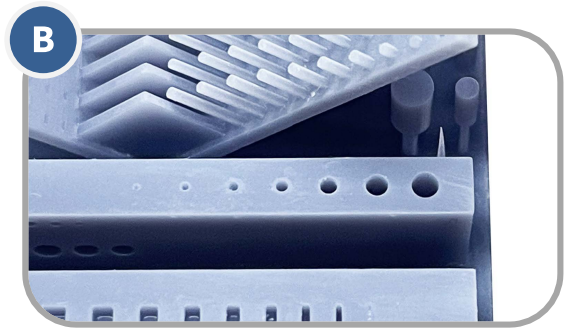

Less holes

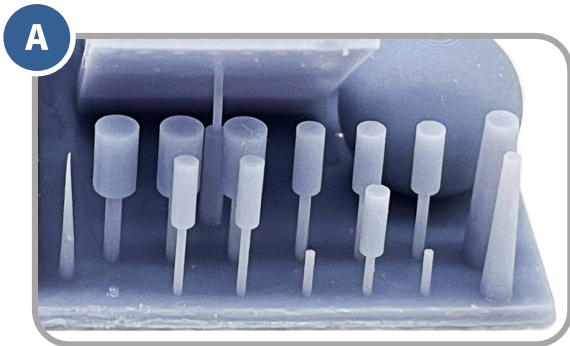

Less cylinder

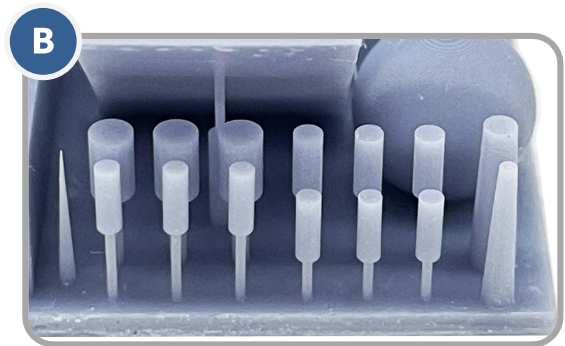

More cylinder

- Model A has more holes and fewer cylinder. If you print by the parameter of model A, more details of model can be printed with high risk of failure.
- Model B has fewer holes and more cylinder. If you print by the parameter of model B, model may be printed successfully yet with some details lost.

In addition, you can compare the bridges, needles or other parts to choose a proper model and find the parameter. If none of them can be chose, adjusting the "normal exposure time (s)" is suggested.

Notice: DO NOT change the file name of "R_E_R_F", because Anycubic 3D printer can only recognize THIS file name to run this function. Also, do not name other file as "R_E_R_F".

Model do not stick to platform

- Bottom exposure time is insufficient. Please increase the exposure time.
- Contact area between the model and platform is small. Please add a raft.
- Bad leveling.

Layer separation or splitting

- The machine is not stable during printing.
- The release film is not tight enough or needs a replacement.
- The printing platform or resin vat is not tightened.
- The lift speed is too fast.
- The model is hollowed without punching.

Layer shift

- Add supports.
- Reduce the lift speed.

Floccules left in resin vat or attached to models

- The exposure time is too long. Reduce the normal exposure time and bottom exposure time.

Resin vat maintenance

- **Remove the cured resin from release film:** Set to Vat Cleaning and remove the residue. Do not use sharp objects to scrape off the residues on the film.

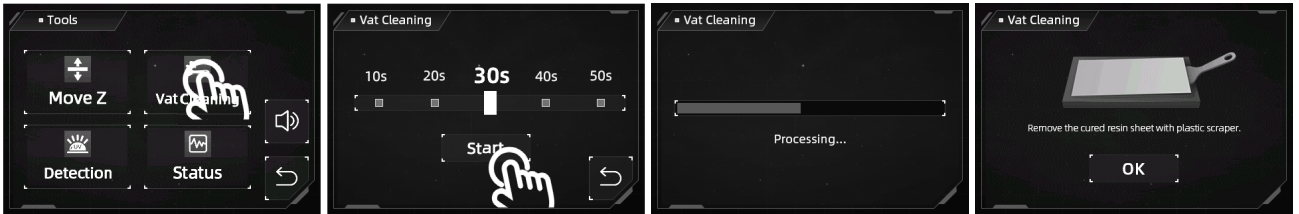

- **Release film replacement:** The statistics of print times and print layers are shown in Status interface. Please check them and replace release film timely to avoid print failure or even the damage to printer.

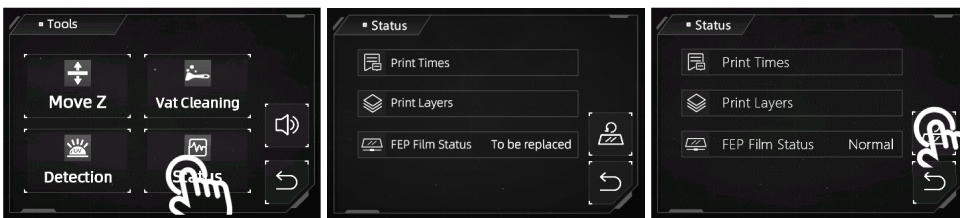

Replace release film
at this time

Click reset button
after replacement

- If you do not use the resin for over two days, store it in an airtight container away from light.

Z axis maintenance

If Z axis makes a noisy sound, please apply lubricant to Z lead screw.

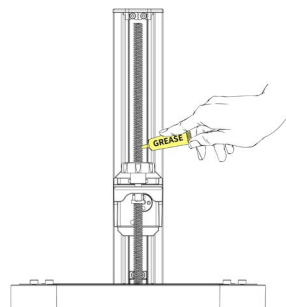

Cleaning

- **Clean the print platform:** Clean platform with alcohol and paper towel.
- **Protect LCD screen :** If the resin cured on screen protector, please replace it immediately to protect LCD screen.
- **Clean the body of printer:** Clean the body of the printer with alcohol.

Thank you for purchasing Anycubic products! Under normal usage and service, the products have a warranty period of up to one year. Please visit Anycubic support center(support.anycubic.com/en) to report any issues with Anycubic products. Our professional after-sale service team would respond within 24 hours and solve the issues.