

 **User Manual**

ANYCUBIC PHOTON M3 MAX

Dear customer,

Thank you for choosing Anycubic products.

Maybe you are familiar with 3D printing technology or have purchased Anycubic printers before. However, we still highly recommend you read this manual carefully, as the installation techniques and precautions can help you avoid any unnecessary damage or frustration.

Please visit <https://support.anycubic.com> to contact us if you have any questions. You can also learn more information from the website, such as software, videos, models.



Anycubic support center

Copyrighted by "Shenzhen Anycubic Technology Co., Ltd ", all rights reserved.

Team Anycubic

Safety Instructions

Always follow the safety instructions during assembly and usage, to avoid unnecessary damage to the 3D printer or individual injury.



Please contact our Customer Service if you have any issues after receiving the products.



Be cautious when using the scraper. Never direct the scraper towards your hands.



In case of emergency, please immediately cut off the power of the 3D printer and contact our technical support.



Anycubic 3D printer includes components that can cause injury.



Keep the Anycubic 3D printer and its accessories out of the reach of children.



Vapors or fumes may be irritating at operating temperatures. Always use the Anycubic 3D printer in an open and well ventilated area.



Do not expose Anycubic 3D printer to any water or rain environment.



Use Anycubic 3D printer in an environment with a temperature of 8°C-40°C and a humidity of 20%-50%. For optimal performance, do not exceed this range. Also, avoid direct sunlight exposure.



Do not disassemble Anycubic 3D printer, please contact technical support if you have any questions.



Contents

1. Product Overview	5
2. In the Box	7
3. Technical Specification	8
4. Recommended Print Parameters	9
5. Menu Directory	10
6. Preparations	13
7. Auto-feed	18
8. Print Test	22
9. Resin Exposure Range Finder	25
10. FAQ	27
11. Machine Maintenance	28

Product Overview

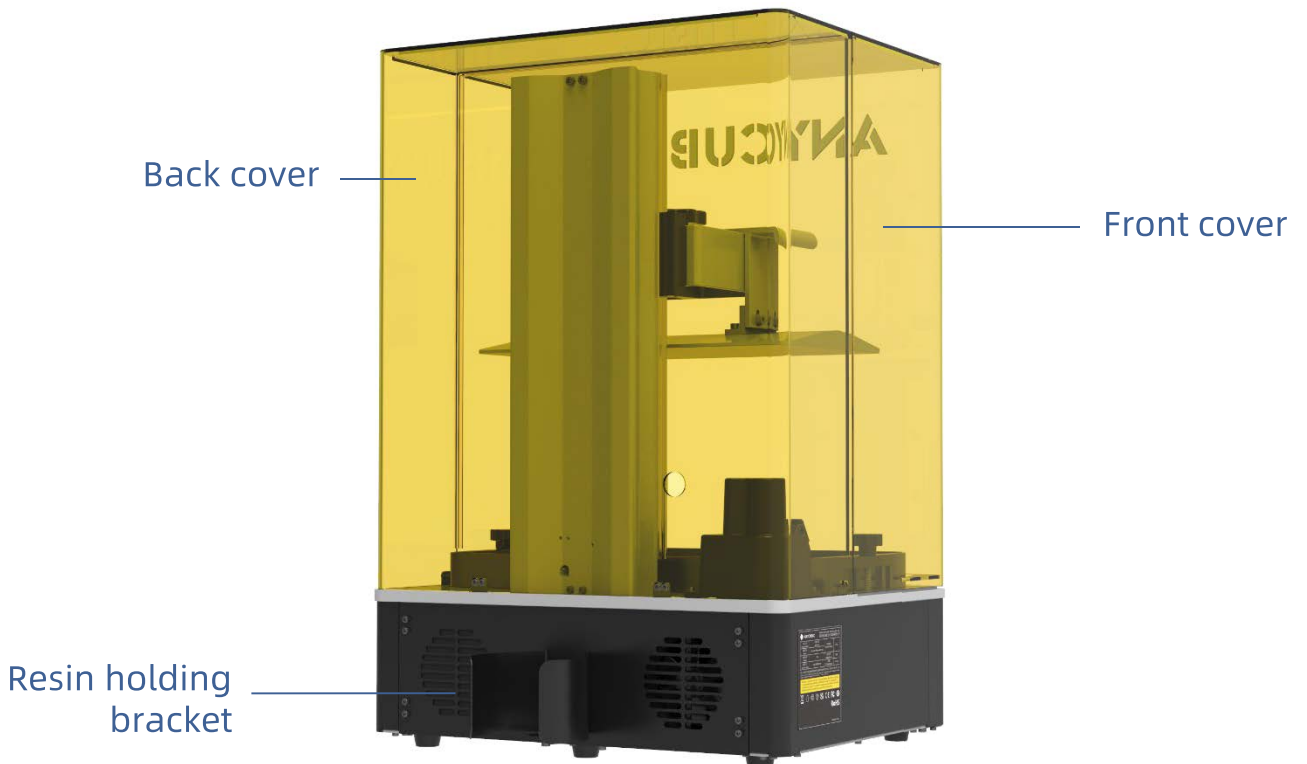
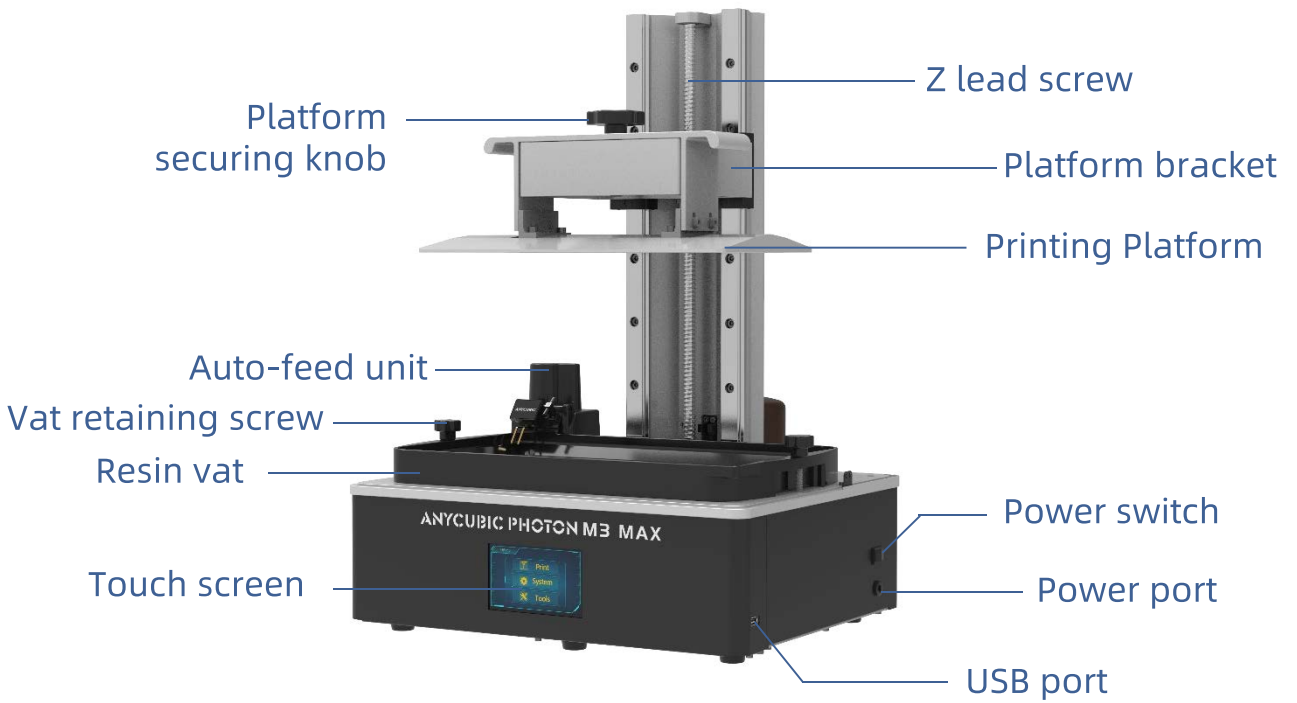





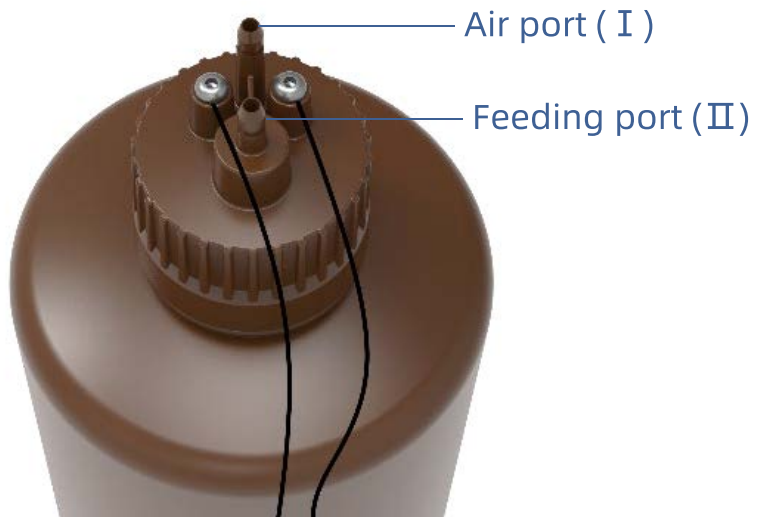
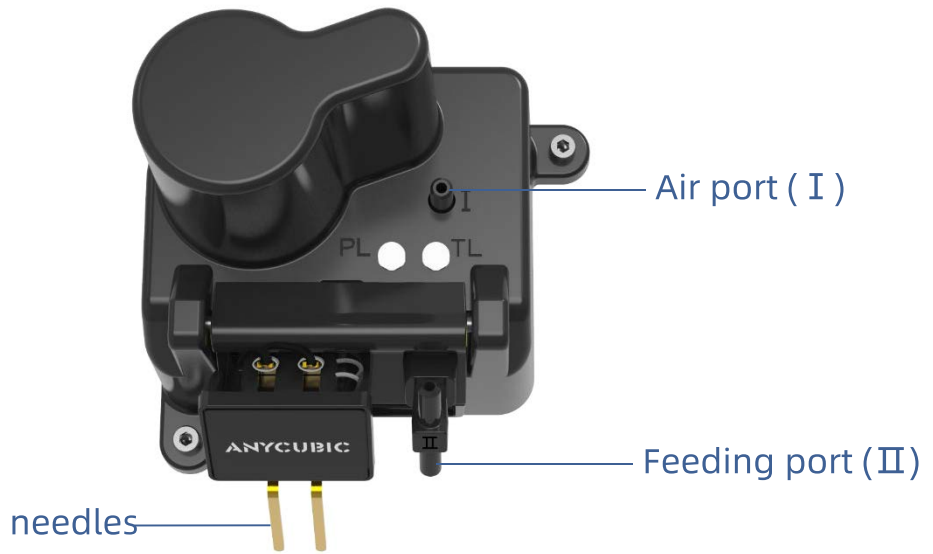



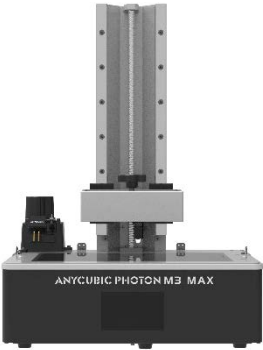

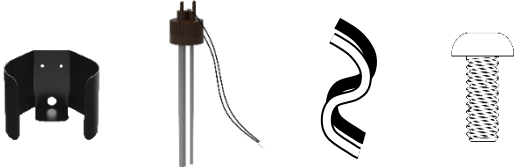

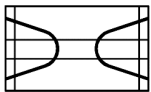
Product Overview

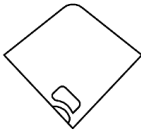
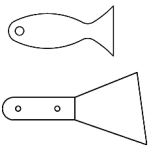
Auto-feed unit

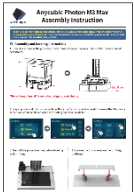
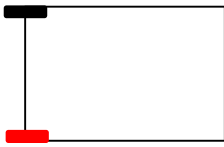

In the Box

			
<p>Anycubic Photon M3 Max</p>		<p>Cover unit (screws: M3*6mm 8PCS)</p>	
			
<p>Auto-feed unit (screws: M3*6mm 2PCS)</p>		<p>Print platform 1PC</p>	<p>Resin vat 1PC</p>
			
<p>Mask 1PC</p>	<p>Gloves 3Pairs</p>	<p>Funnel 5PCS</p>	<p>Scrapers 2PCS</p>
			
<p>USB memory 1PC</p>	<p>Assembly Instruction 1PC</p>	<p>Screen protector kit</p>	<p>Leveling paper 1PC</p>
			
<p>Power adaptor 1PC</p>		<p>Tool kit</p>	

Technical Specification

Printing

System	Anycubic Photon M3 Max
Operation	4.3-inch Color TFT Screen
Software	Anycubic Photon Workshop
Connectivity	USB memory stick

Specifications

Technique	LCD Shadow Masking
Light source	UV-LED (wavelength 405nm)
XY Resolution	46 μ m 6480*3600 (7K)
Z axis Accuracy	0.01 mm
Suggested Layer Thickness	0.01 ~ 0.1mm
Rated power	120 W

Physical Dimensions

Dimension	400 mm(L)*408 mm(W) *596 mm(H)
Build volume	298 mm(L) *164 mm(W) *300 mm(H)
Materials	405 nm UV-resin
Net weight	~21 kg

Recommended Print Parameters

Layer Thickness	0.05 mm
Normal Exposure Time	3 s
Off Time	2 s
Bottom Exposure Time	30 s
Bottom Layers	6
Z Lift Distance	10 mm
Z Lift Speed	4 mm/s
Z Retract Speed	4 mm/s
Anti-alias	1

Note:

The recommended printing parameters above is for reference only, which is more suitable for Anycubic resin.

Menu Directory

Home menu

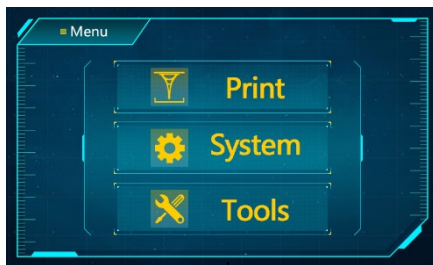

Print

System

Tools

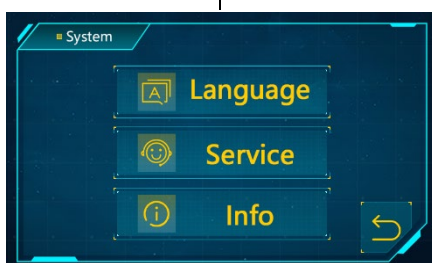

Print

File List:



Switch USB file list to local file list

Page up

Page down

Return to the Home Menu

Click Files

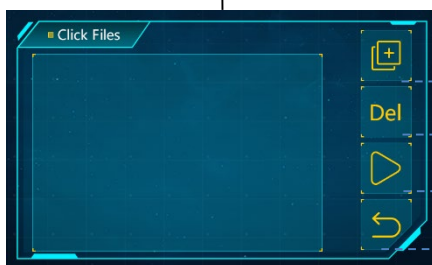

Save to local file list

Delete the current file

Click to start printing

Return to the Print Menu

Menu Directory

System

Language: Change language(English/Chinese)

Service:



Official website

Return to the System Menu

Information:



Product system

Product ID

System version

Return to the System Menu

Tools

Move Z:

Move the Z axis downwards

Move the Z axis upwards

Stop moving the Z axis



Move Z by
0.1mm/1mm/10mm

Return to Zero

Return to the Tools Menu

Reset the zero point

Menu Directory

Detection:

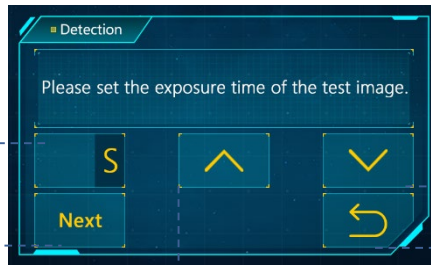

Click to set the test time

Test LED and LCD for the preset time

Reduce the test time

Return to the Tools Menu

Increase the test time

Exposure:

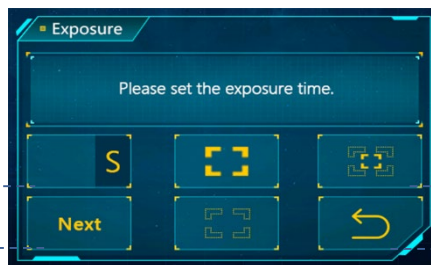

Click to set the exposure time

Expose for the preset time

Select one of the images to expose

Return to the Tools Menu

Gear icon: Enter to set feeding speed

Tap icon: Enable/disable the auto-feed function

Horn icon: Turn on/off the screen sound

Preparations

1. Unpack and remove the protective metal frame, foam and zip ties. Take out the machine and its accessories.

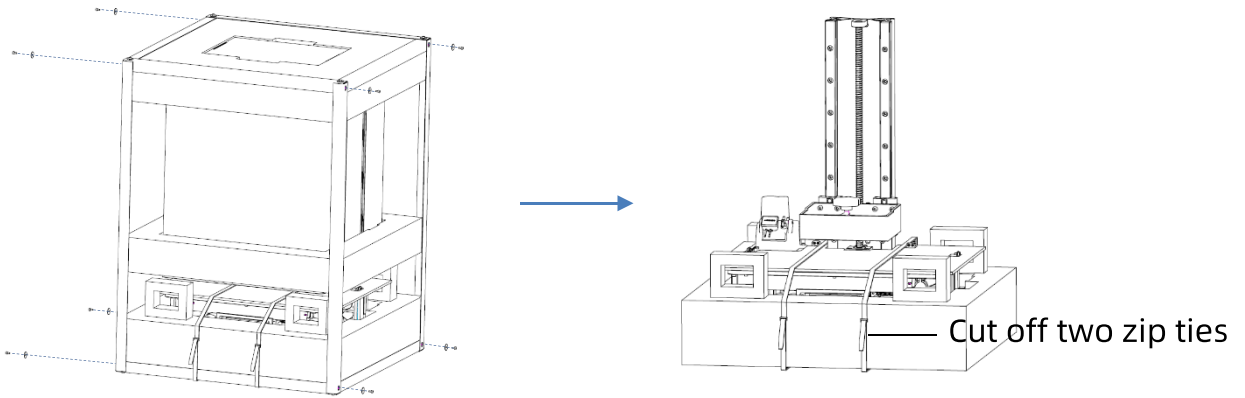

*Be cautious of metal frame's sharp edges to avoid injury.

2. Plug in power and turn on the machine. Raise Z axis to a certain height that the curing screen will not be scratched when the printing platform is installed.

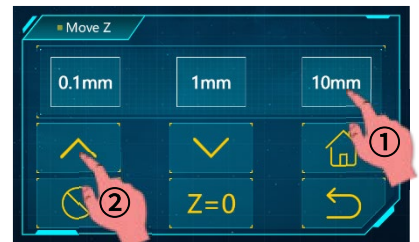
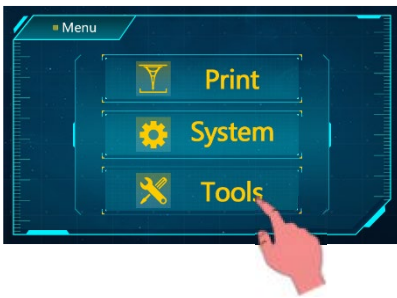

3. Tear off the protective film before leveling and printing.

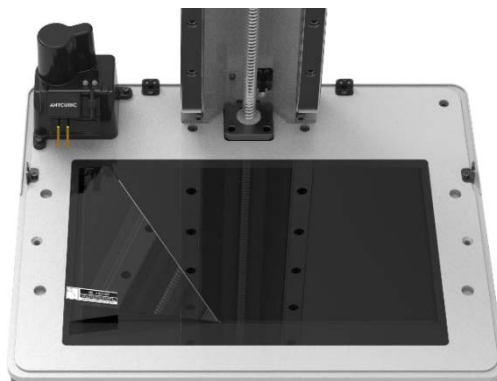

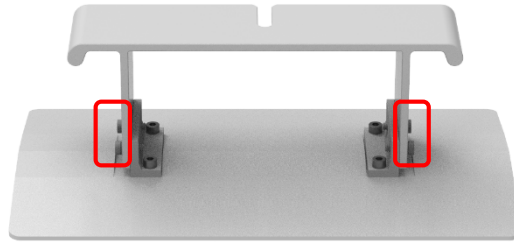

Preparations

4. Loosen the four screws on the printing platform.

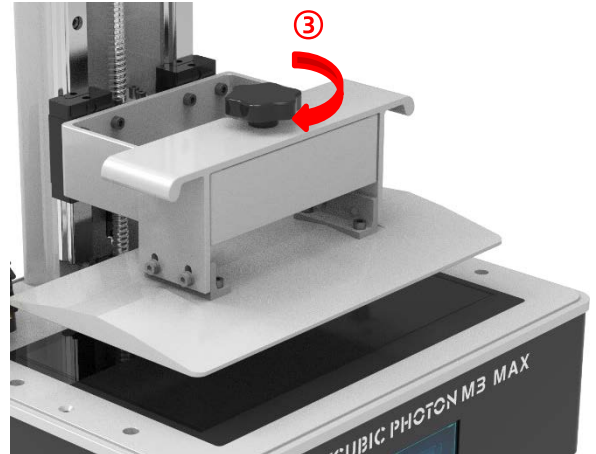
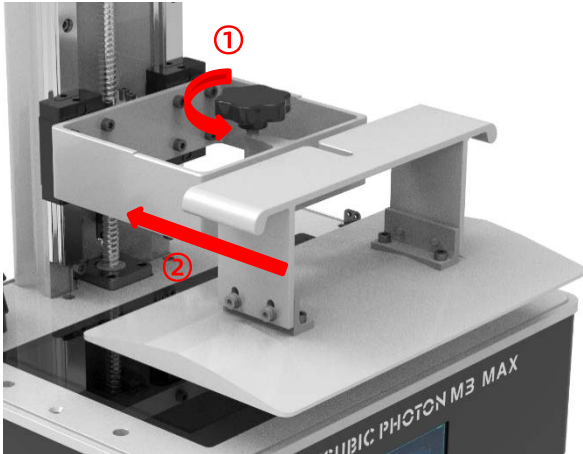

5. Install the printing platform.



6. Place a leveling paper on the curing screen. Then click “” on touch screen. Wait for the Z axis to descend and stop automatically.



Preparations

7. Use your fingers to press the platform gently, to let it fit evenly on the curing screen. Then, tighten the four screws on the platform.

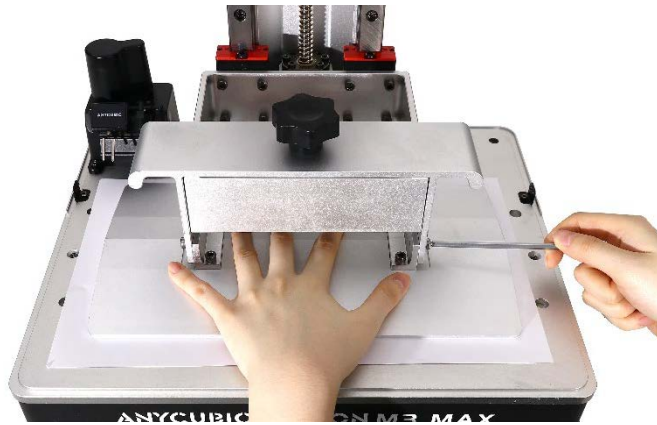

8. Click "Z=0" to save the zero position, and then click "Enter" on the pop-up window. Till now, the leveling process is finished. Click "Enter" again and take out the leveling paper.

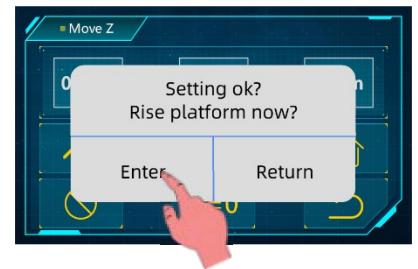
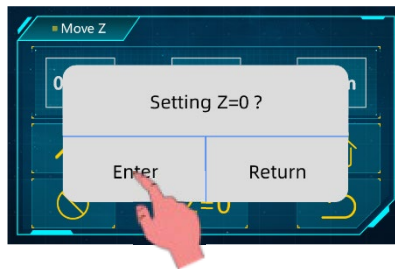

9. Detection: Raise printing platform until the curing screen can be observed completely. Return to Tools menu and click "Detection", set the test time and then click "Next". The curing screen should display a complete image as shown below.

Click here to set the test time

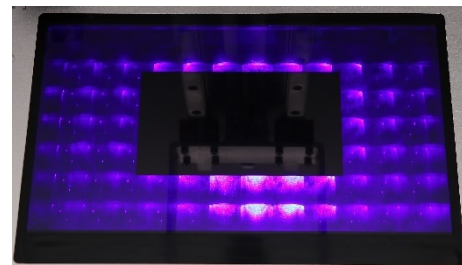
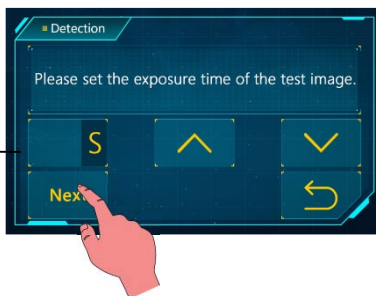

Preparations

10. Install resin vat with both needles being set in it.

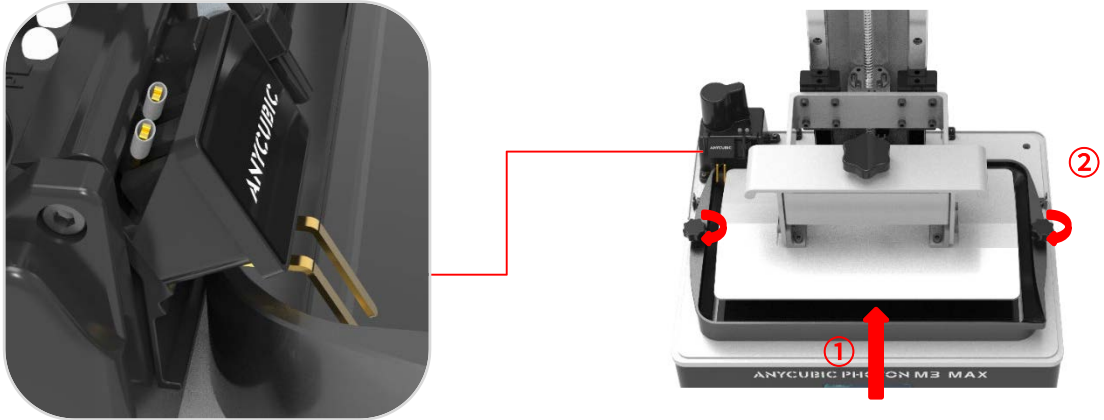

11. Install the back cover, Then, if the auto-feed unit is not needed at the moment, the installation is finished.

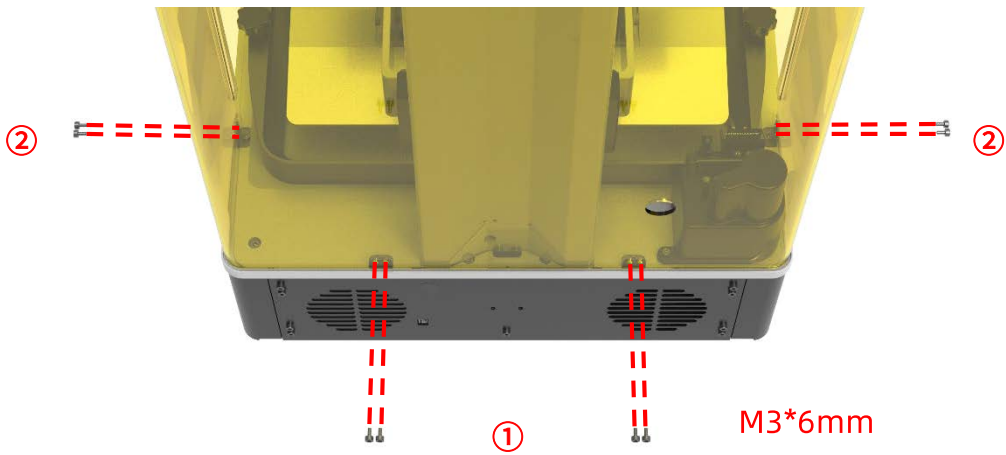

12. Turn the machine back and install resin-holding bracket first.

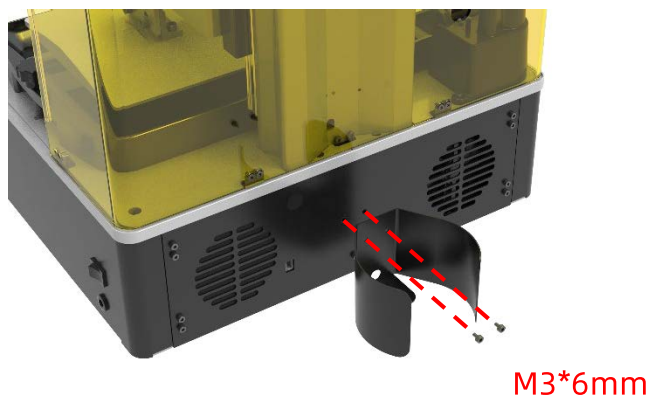

Preparations

13. Put the cap part on **Anycubic 1kg resin bottle** and tighten it. Place resin bottle on the bracket and connect the cap part wire to machine.

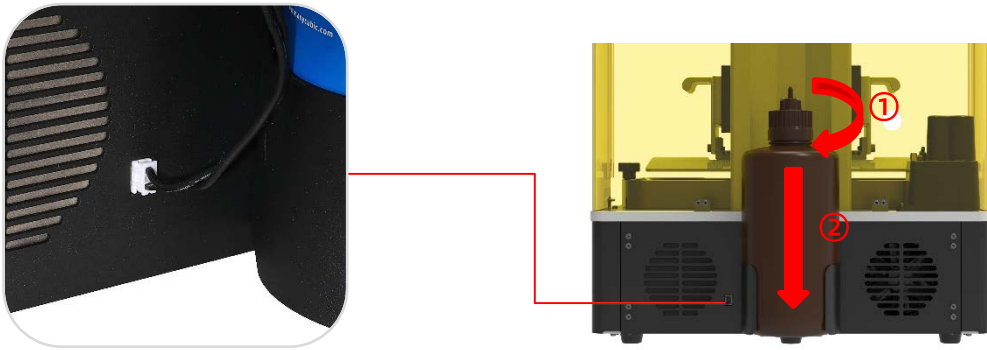

TIPS: When you change resin, it is recommended to tighten the cap through rotating bottle to avoid blockage caused by twisting pipes.

14. Pass two pipes through the limit hole on the back cover. Connect ports **II** with feeding pipe (black) and connect ports **I** with air pipe (transparent) . Please completely follow this way of connection to avoid the damage of auto-feed unit.



Auto-feed

1. Instructions

Ensure the auto-feed unit has been installed and the resin in bottle is enough to print. Click "Tools" → "  " to enable the function. It will feed in automatically if resin in the vat is sufficient during printing.



Click to enable auto-feed function

- Auto-feed only works when machine is printing.
- The unit feeds every five minutes normally.
- Red light indicates that resin is not detected by needles. When needles detects resin, the light goes off.
- Green light indicates that the unit has been powered.

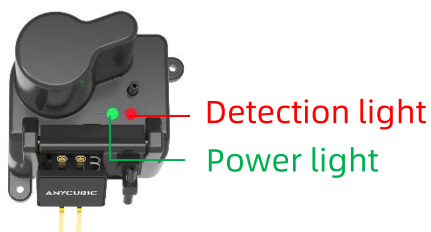

If the insufficiency of the resin in holder is detected when it is printing, the machine will beep to warn and disable auto-feed function. Please add or change resin first and enable the function in Set up if necessary.

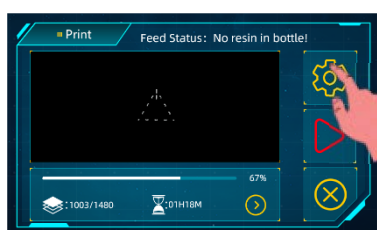

Click to enable auto-feed function

Auto-feed

Notice:

1. If you use non-Anycubic resin, it is suggested to check whether red light goes out normally when resin reaches both needles before printing. If not, the resin cannot be automatically fed.
2. To save resin, pour the remaining resin that is out of the reach of pipes to resin vat.
3. **DO NOT vigorously shake or turn over the resin bottle when cap part is installed. If the inside of cap is stained by resin, please immediately clean it to avoid malfunction or damage of auto-feed unit.**

2. Troubleshooting

Issues	Troubleshooting		Solution
Do not feed in during printing	Red light is off	The resin in vat reaches both needles	Wait until the resin is insufficient.
		The resin in vat does not reach both needles	The power light(green) is off, reconnect the wire under detection unit.
			Two needles touch each other. Please contact the tech support.
			Resin abnormally gets into the air pipe to cause malfunction of the unit. A replacement is needed.

Auto-feed

Issues	Troubleshooting		Solution
Do not feed in during printing	Red light is on	Waiting status	It feeds every five minutes normally. Wait for the next feeding.
		Feeding status	The wrong connection of air pipe and feeding pipe cause malfunction of auto-feed unit. A replacement is needed.
The machine shows resin in bottle is insufficient and disable auto-feed function	Resin in bottle is insufficient		Add resin to bottle
	Resin in bottle is sufficient but machine shows feed status as "No resin in bottle!"	The two screws on the cap is loosened	Tighten the screws
		The wire connecting cap and machine is disconnected	Connect the wire to machine
Nothing wrong with screws and wire	The resin cannot be used for auto-feed		

Auto-feed

Issues	Troubleshooting	Solution
Consistent feeding cause overflow of resin	Red light does not go off when resin reaches both needles	The resin cannot be used for auto-feed unit
	The lowest points of needles rise	Check whether you completely follow the assembly instructions
		Two needles are distorted. Please contact the tech support.

***Please contact the tech support if the troubleshooting above cannot solve your problem.**

Print Test

*The release film on the resin vat is consumable. Please pay attention to the status of release film on the touch screen and replace the film timely.

Please check the release film carefully before and after every printing. If the film is broken, replace it immediately to avoid further damage to the machine.

1. Make sure you wear masks and gloves (to avoid direct skin contact with resin), slowly pour resin into the vat with **resin level not exceeding the vat's maximum scale**.



2. Put on front cover. Insert the USB memory into the USB port, print the test file in it.

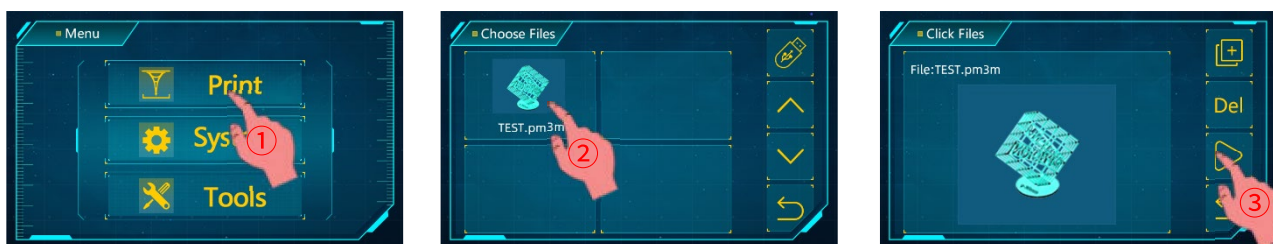

Notes:

- ① It is recommended that use the USB drive we provided. Otherwise, please use the USB drive whose memory size **not exceed 8G** and ensure that it is formatted to **FAT/FAT 32**.
- ② The print files should be placed at the root directory of USB drive to avoid read error.

If it is necessary, click "Pause" to pause the printing and wait for platform rising automatically. Then click "Start" to resume printing.

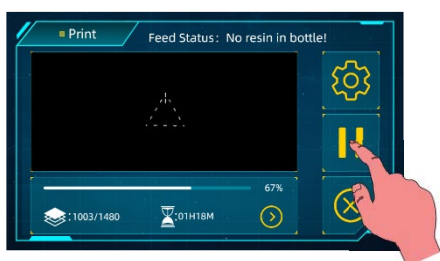

click to pause

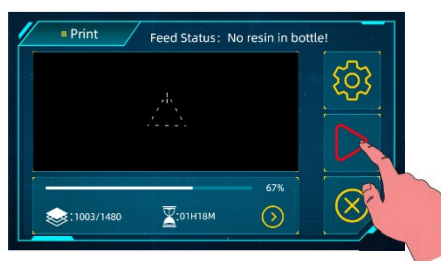

click to start

Print Test

File list

Print file list is consist of USB driver file list and local file list. Select one USB driver file and click “” icon in its interface to save it to local file list. The local file can be printed without USB driver.

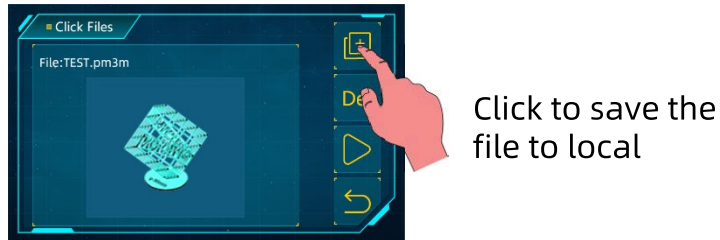

Exposure off compensation

Exposure off time is the interval between printing platform retracts to the lowest point and UV light turns on. When the exposure area is large during printing process, due to the surface tension and resin characteristic, there may be problems such as delay of Z-axis or delay of resin reflowing, causing print failure. **It is suggested to enable exposure off compensation to improve success rate.**



The compensation only works on bottom layers and layers with large area. In normal layers, off time is automatically added according to the area of layers; the larger the area, the longer the off time.

For large print objects, the compensation can reduce the risk of layers separation or base falling off to avoid print failure. For the smalls, it can prevent their bases from thickening.

Exposure off compensation, which is enabled by default, adds print time. If the print object or its area of layers is small, you can disable the function in Set up.

Handling models and residues

- After printing, remove the platform when resin stop dropping from the platform. Remove the model by metal scraper and then wash it with 95% alcohol or other detergent. It may need post-curing to achieve better hardness by being exposed directly to sunlight or a UV-curing machine.
- After printing, there might be some cured resin left in the vat. Please clean the vat timely, and filter the remaining resin by a funnel. Otherwise, it may cause damage to the release film or LCD screen. If you do not use the resin now, it is recommended to store it in an airtight container away from light.

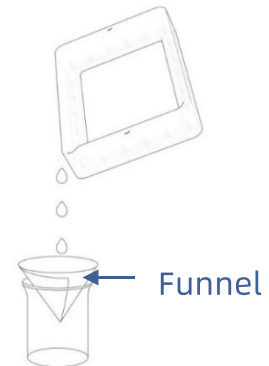
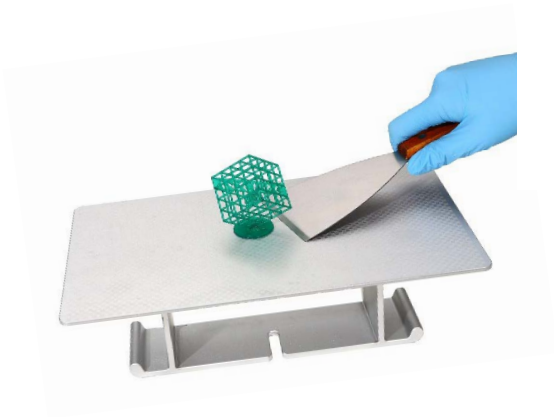

Resin Exposure Range Finder

“R_E_R_F” is an abbreviation for “Resin Exposure Range Finder”. This function is used to find out the optimal exposure parameters for different resins.

1. Import the R_E_R_F file which is saved on USB drive into the slicing software. There are eight models in the file. The exposure time for model 1 is equal to "normal exposure time (s)" of the file, and the exposure time for other models will be increased by an increment of **0.25 s**.

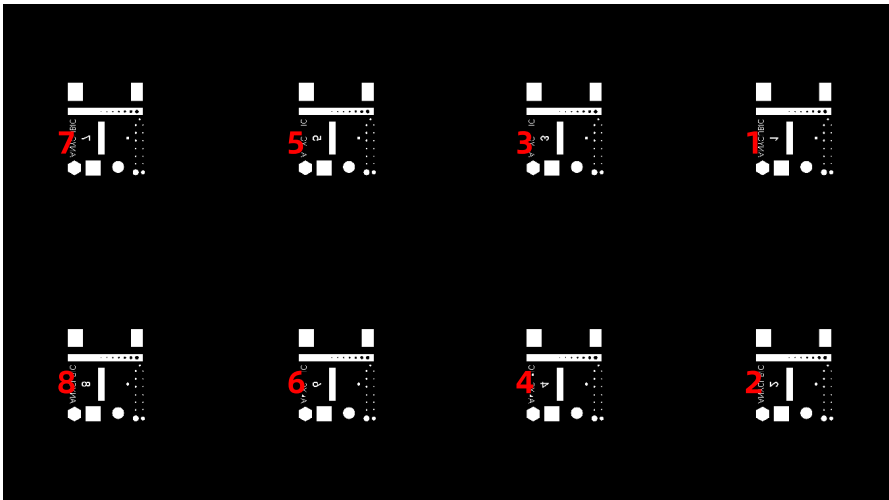

The numbers on the models indicate their order

2. According to the personal requirement, adjust the exposure time of the models by modifying "normal exposure time (s)" of the file. When exposure time for Model No. 1 is changed, the exposure time for other models will be increased by an increment of **0.25 s**.

For example, when normal exposure time is set to 1.5 s, the exposure time for Model No.1-8 is: 1.5 / 1.75 / 2 / 2.25 / 2.5 / 2.75 / 3 / 3.25 s.

3. After printing, remove and clean the models. Compare the print effect of models and choose the model's exposure time that meets your needs as the print parameter. Take a comparison of model A&B as an example.

Resin Exposure Range Finder



More holes

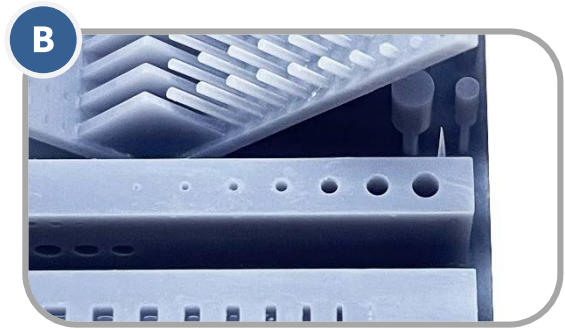

Less holes

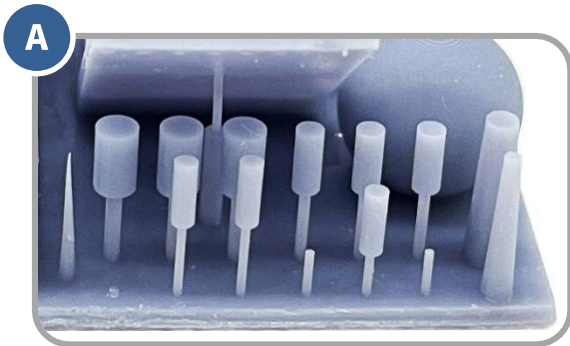

Less cylinder

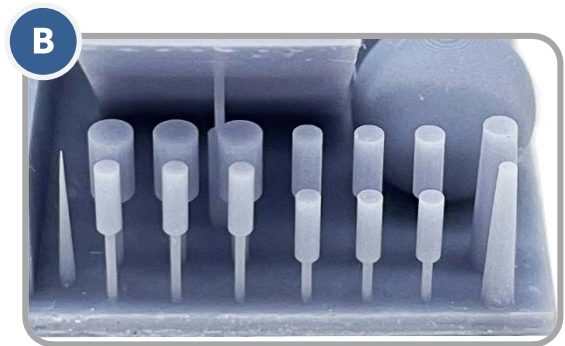

More cylinder

- Model A has more holes and fewer cylinder. If you print by the parameter of model A, more details of model can be printed with high risk of failure.
- Model B has fewer holes and more cylinder. If you print by the parameter of model B, model may be printed successfully yet with some details lost.

In addition, you can compare the bridges, needles or other parts to choose a proper model and find the parameter. If none of them can be chose, adjusting the "normal exposure time (s)" is suggested.

Notice: DO NOT change the file name of "R_E_R_F", because Anycubic 3D printer can only recognize THIS file name to run this function. Also, do not name other file as "R_E_R_F".

Model do not stick to platform

- Bottom exposure time is insufficient, increase the exposure time.
- Contact area between the model and platform is small, please add raft.
- Bad leveling.

Layer separation or splitting

- The machine is not stable during printing.
- FEP film in the vat is not tight enough or it need a change for new one.
- The printing platform or resin vat is not tightened.
- The lift speed is too fast.
- The printing object is hollowed without punching.

Layer shift

- Add supports.
- Reduce the lift speed.

Floccules left in resin vat or attached to models

- The exposure time is too long. Reduce the normal exposure time and bottom exposure time.

Machine Maintenance

Resin vat maintenance

- **Remove the cured resin from release film:** Set full-screen exposure for 20s and then remove the cured resin sheet to protect the film. Do not use sharp objects to scrape off the residues on the film.



- Do not left resin in resin vat for over two days when it is unused. Please filter and store the resin properly.

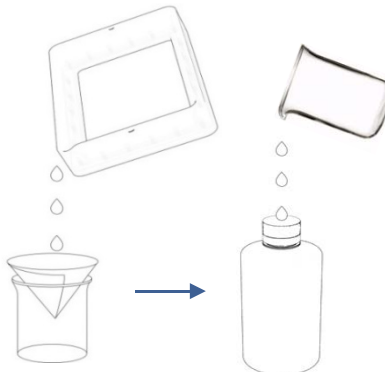

Z axis maintenance

If Z axis makes a noisy sound, please apply lubricant to Z lead screw.

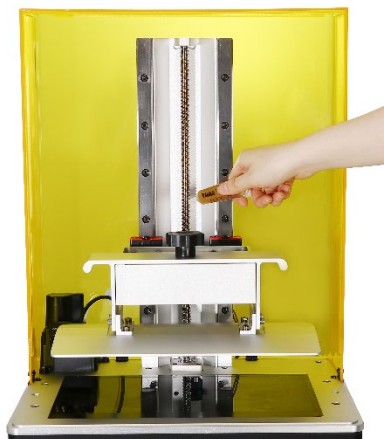

Machine Maintenance

Cleaning

- **Clean the print platform:** Clean platform with alcohol and paper towel.
- **Protect LCD screen:** If the resin cured on screen protector, please replace it immediately to protect LCD screen.
- **Clean the body of printer:** Clean the body of the printer with alcohol.

Thank you for purchasing Anycubic products! Under normal usage and service, the products have a warranty period of up to one year. Please visit Anycubic support center(support.anycubic.com/en) to report any issues with Anycubic products. Our professional after-sale service team would respond within 24 hours and solve the issues.